

# USER MANUAL

For working with a Pellet Fireplace



[www.greyko.com](http://www.greyko.com)



Producer: GREYKO ENGINEERING LTD

Address: Strandja 13 Street, 5100 Gorna Oryahovitsa,  
Bulgaria

Phone number: +359 618 8 40 19

E-mail: office@greyko.com

Website: www.greyko.com

### **Thank you for choosing our product!**

Your pellet fireplace has been designed and tested in accordance with the requirements of standards EN 14785: 2006; BDS EN 60335-1; BDS EN 60335-2-102; BDS EN 55014-1; BDS EN 55014-2; BDS EN 61000-3-2; BDS EN 61000-3-3 and complies with approved technical documentation.



#### **ATTENTION:**

PLEASE ACQUAINT CLOSELY AND CAREFULLY WITH THIS INSTRUCTION BEFORE UNDERTAKING ANY ACTIONS IN MOUNTING AND OPERATION OF THIS INSTALLATION. NON-OBSERVANCE OF THE INDICATIONS DESCRIBED IN THE INSTRUCTION CAN CAUSE DAMAGES AND CONSEQUENCES FOR WHICH THE PRODUCER IS NOT RESPONSIBLE.

Client care:



Important! Attention! Shows important information



Shows information concerning the environmental protection

We reserve the right to change

# CONTENT

<b>1. Safety measures</b>	<b>3</b>
<b>2. Description and technical Data of the Pellet Fireplace Bijou</b>	<b>3</b>
<b>2.1. Delivery and unpacking</b>	<b>3</b>
<b>2.2. Description of the facility</b>	<b>3</b>
<b>2.3. Technical data of the pellet fireplace Bijou</b>	<b>6</b>
<b>3. Installation of Bijou pellet stove</b>	<b>6</b>
<b>3.1. Basic rules</b>	<b>6</b>
<b>3.2. Flue gas removal system</b>	<b>7</b>
<b>3.3. Introducing fresh air for combustion process</b>	<b>9</b>
<b>3.4. Connecting to the electrical system</b>	<b>10</b>
<b>3.5. Connecting to the heating system</b>	<b>10</b>
<b>4. Used fuel</b>	<b>11</b>
<b>5. Operation of the Bijou pellet fireplace</b>	<b>12</b>
<b>5.1. Safety measures.</b>	<b>12</b>
<b>5.2. Switch on the fireplace</b>	<b>12</b>
<b>6. Work on the Bijou pellet fireplace controller</b>	<b>12</b>
<b>7. Cleaning and maintenance of the Bijou pellet fireplace</b>	<b>36</b>
<b>8. Service</b>	<b>40</b>
<b>9. Warranty conditions</b>	<b>40</b>
<b>10. Actions after stopping the use of the Bijou pellet fireplace</b>	<b>41</b>
<b>11. Electric circuit diagram</b>	<b>42</b>
<b>12. A Guide to Working with a Web Based Remote Monitoring and Control System</b>	<b>43</b>
<b>13. User Interface of the Remote Monitoring and Control System</b>	<b>50</b>
<b>14. Restore a forgotten password</b>	<b>51</b>
<b>15. Change user name</b>	<b>52</b>
<b>16. Password change</b>	<b>52</b>
<b>17. General information about the devices you are entitled to manage</b>	<b>52</b>
<b>18. Add a new device to your personal account</b>	<b>53</b>
<b>19. Giving access to your devices to other system users</b>	<b>54</b>
<b>20. Input to the interface for monitoring and controlling your appliances</b>	<b>55</b>
<b>21. Releasing a device connected to the system</b>	<b>55</b>
<b>22. FACTORY SETTINGS OF THE BIJOU PELLETT FIREPLACE</b>	<b>55</b>

## 1. Safety measures.



### Safety Information

Carefully read the following instructions before installing and using the facility. The producer is not responsible for damages caused by wrong installation and use. Always save the instructions for future references.

#### Safety for children and people with disabilities

- \* This facility may be used by children over 8 years of age as well as persons with reduced physical, sensory and mental abilities or persons without experience and knowledge only if they are under surveillance or instructed on safe use of the facility and possible risks.
- \* Do not let children play with the facility.
- \* Keep all packaging materials out of the reach of children.
- \* Keep children and pets away from the door of the facility when it is open.
- \* Cleaning and maintenance should not be carried out by children unless they are under surveillance..

## 2. Description and technical Data of the Pellet Fireplace Bijou.

### 2.1. Delivery and unpacking:

The pellet fireplace is delivered on a wooden pallet wrapped in stretch foil and a wooden case.



**ATTENTION!** Check for visible defects!



**ATTENTION!** Check the integrity of the glass on the door!



**ATTENTION!** Open the pellet hopper and check its contents:

- Control module - 1 pc
- Power cord - 1 pc
- Spare fuses - 0.8A - 1 pc, 5A - 1 pc, 6A - 1 pc
- DHW heating regulator (domestic hot water) - 1 pc
- Fuel Reflector with four holes - 1 pc
- Combustion chamber INOX - 1 pcs

### 2.2. Description of the facility.

You get:

- Pellet burner Bijou (containing hopper, circulator pump, expansion vessel) - 1 pc;
- Control module – 1 pc;

- Fuel Reflector with four holes - 1 pc;
- Combustion chamber INOX - 1 pcs;
- DHW heating regulator (domestic hot water) - 1 pc;
- Power cord - 1 pc;
- Spare fuses - 0.8A - 1 pc, 5A - 1 pc, 6A - 1 pc;
- Operating Instructions - 1 pcs;
- Warranty card - 1 pc;
- Wooden packaging - 1 pc.

Pellet fireplace Bijou - 16kW is suitable for binding to heating installation of apartments, offices and other small living quarters. The combustion chamber is protected by a hermetic door with ceramic glass resistant to temperatures up to 700 ° C. Thanks to this embodiment, the fire can be viewed while preventing contact with it. The burner is made of fireproof INOX. Fig. 1 shows the elements of the pellet fireplace.

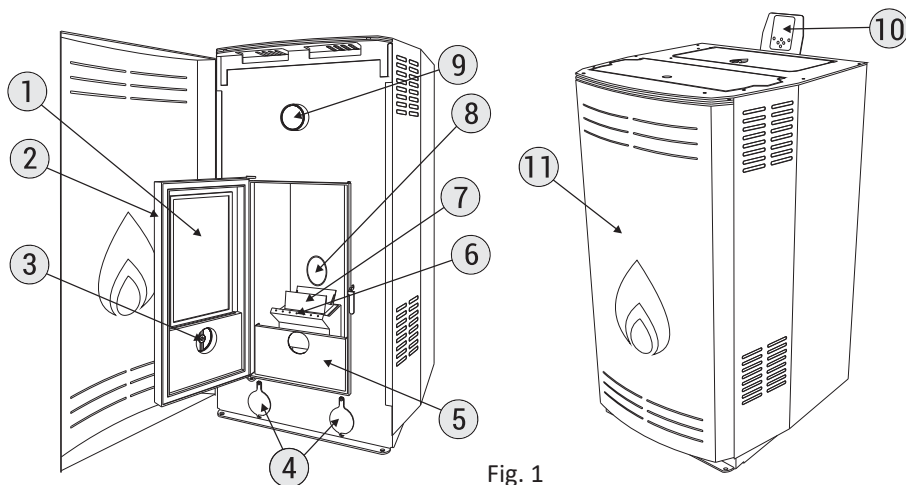
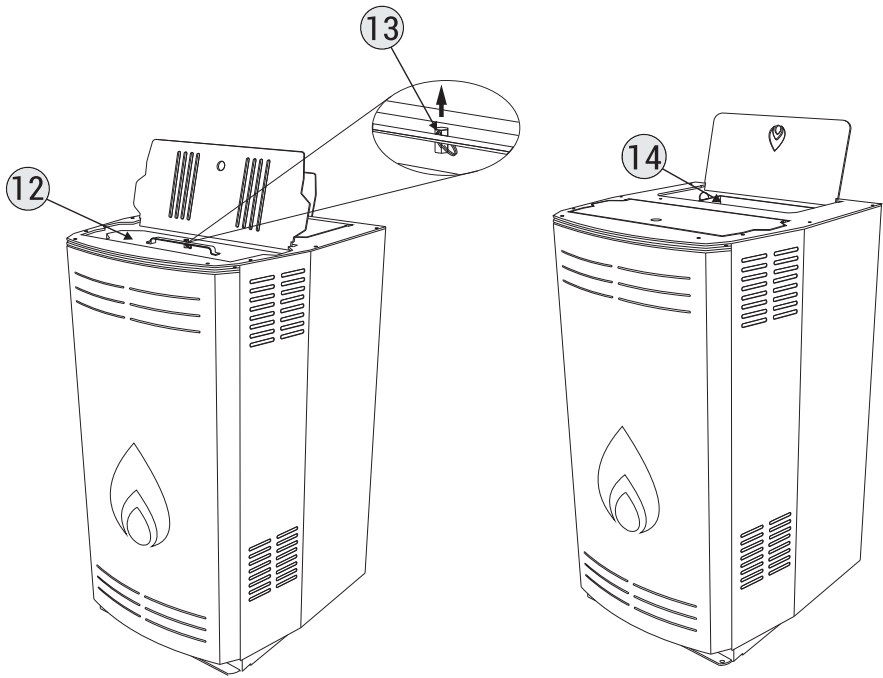

Fig. 1

1	Glass
2	Door
3	Safety detonation valve
4	Cleaning openings
5	Ashtray
6	Air holes for glass cleaning
7	Combustion chamber
8	Openers for pellet insertion
9	Pressure gauge
10	Control module
11	Front decorative panel



12	Inspection cover for flue pipe cleaning
13	Ring for cleaning of pipes
14	Pellet hopper



**WARNING!** During operation of the appliance, the combustion chamber must always be closed!



**WARNING!** The pellet stove should not run without water in the system and pressure of not less than 1 bar. In the event of failure to comply with this condition, the fireplace may be damaged.

## 2.3. Technical data of the pellet fireplace Bijou:

Model GREYKO BIJOU	Dimensions	10 kW	16 kW	25 kW
Rated power	kW	10	16	25
Spatial heat output	kW	1.1	1.7	3
Heat output of the water heater	kW	8.9	14.3	22
Reduced power	kW			
Flue gas temperature at rated power	°C			
Flue gas temperature at reduced power	°C			
Amount of flue gas at rated power				
Flue gas temperature at Amount of flue gases reduced power				
Traction at rated power				
Traction at reduced power				
CO content in the smoke gas calculated to 13% O <sub>2</sub> at rated thermal input				
CO content in the smoke gas calculated to 13% O <sub>2</sub> at reduced heat output				
Water system volume	L		30	45
Height	mm	1056	1056	1056
Width	mm	585	585	585
Depth	mm	614	614	672
Weight	kg	169	183	202
Chimney (flue gas outlet), diameter	mm	Φ80	Φ80	Φ80
Inlet air pipe, diameter	mm	Φ40	Φ40	Φ40
Pellet hopper capacity - maximum amount	kg	45	45	45
Exit water jacket	"	G1"	G1"	G1"
Water jacket entry	"	G1"	G1"	G1"
Working pressure	Bar	2	2	2
Average fuel consumption per hour	kg/h	1.2	1.8	2.8
Time to burn a full bunker with pellets at maximum power	h	22	15	9
Efficiency	%	93	93.5	93
Nominal electrical power	W	90	90	90
Maximum electrical power	W	380	380	380
Power supply voltage	V	230	230	230
Recommended fuel		Wood pellets with a diameter of 6-8 mm. EN14961: 2011		

All national and regional normative acts as well as European standards must be observed when installing the appliance.

## 3. Installation of Bijou pellet stove

### 3.1. Basic rules:

For the correct and flawless operation of the pellet fireplace, proper bonding, assembly and adjustment is required. Proper fitting of the flue gas system is required.



**ATTENTION! The bundling, installation, setting and commissioning of the appliance must only be carried out by an authorized installer! The warranty does not cover errors made during installation!**

The facility must be at least 500 mm away from flammable materials!

If the floor is made of flammable material, it must be pre-insulated.

The installation of the facility must be as close as possible to the flue gas system.

The metal pipes for smoke removal must be at a distance of 1.5 m from flammable materials.

During the operation of the fireplace the handle of the door is hot. It should be serviced with a heat-resistant glove.

The room used to install the facility must have a volume greater than 40 m<sup>3</sup>.

The room must have a fresh air compensation.

Do not use any fuels other than specified by the manufacturer!

Pre-check the status of the flue gas system (chimney).

Do not install the facility in a bathroom, bedroom or premise with a second heating facility that uses solid or liquid fuel!

Remove the packaging before installation.



**IMPORTANT!**

You must install a filter for water type "Y" directly before the circulating pump!

### 3.2. Flue gas removal system.



**IMPORTANT! The flue gas should only be used from the pellet stove and no other appliances should be connected to it.**

For flue gas extraction must use components and equipment that comply with existing standards. To avoid condensation on the flue pipes, both conventional flue ducts and heat insulated pipes could be used. You must not use pipes with diameter less than 80 mm!

Before the installation, the smoke exhausting / outlet system must be thoroughly checked by an authorized specialist.

The smoke outlet made of metal pipes must be grounded in accordance with the applicable legal provisions. The chimney grounding must be independent of the facility.

The chimney must be constructed with materials that conform to the applicable standards:

- diameter between 80 and 160 mm (if it is rectangular 160x160 mm);
- wind resistant top;
- sealing and insulation;
- inspection hole at the lowest part.

It is advisable to avoid the use of horizontal pipes and, if they are to be used, they should be no more than 3 m in length and a slope of not less than 5%.

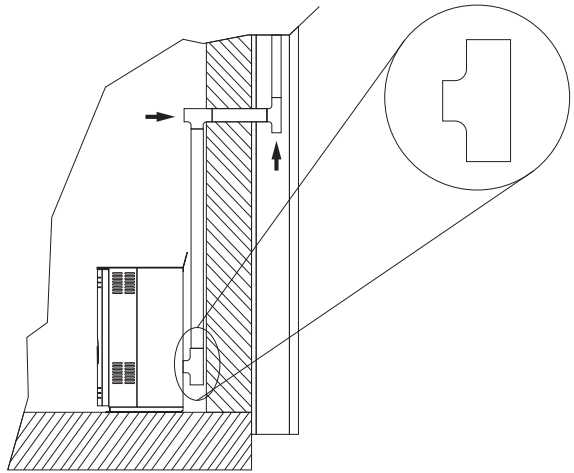
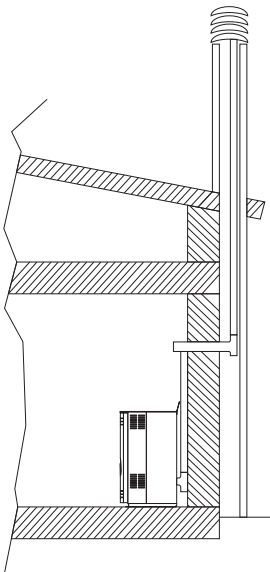
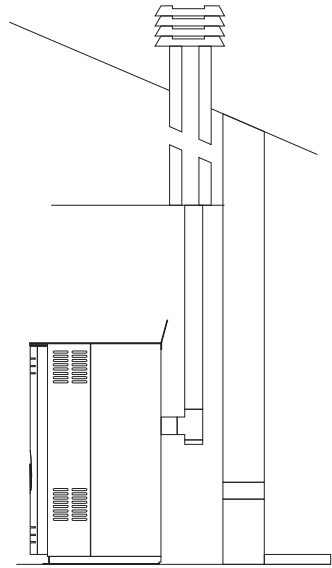
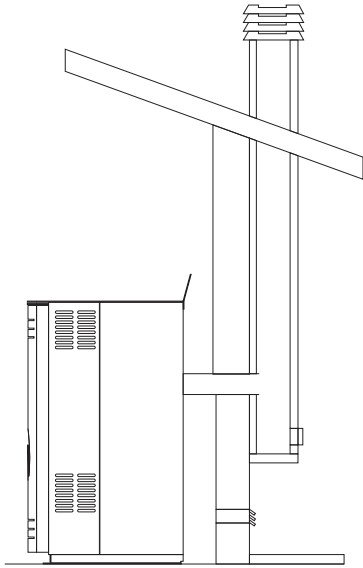

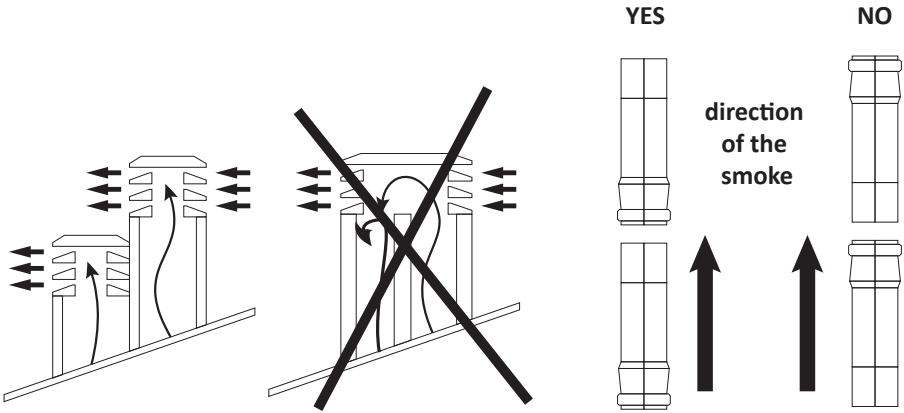

### 3.3. Introducing fresh air for combustion process.

The room in which the pellet equipment is installed must have a ventilation tube with a corresponding grid, which is placed, for example, on the wall of the room and is facing outwards. This ensures the proper operation of the equipment and consequently lower pellet consumption. It is not recommended to directly connect the equipment to outside air!

**In the presence of a second combustion chamber in the room, the air compensation opening must be adapted to the required air for both devices! For the proper operation of the Bijou pellet stove, use a compensation hole.**

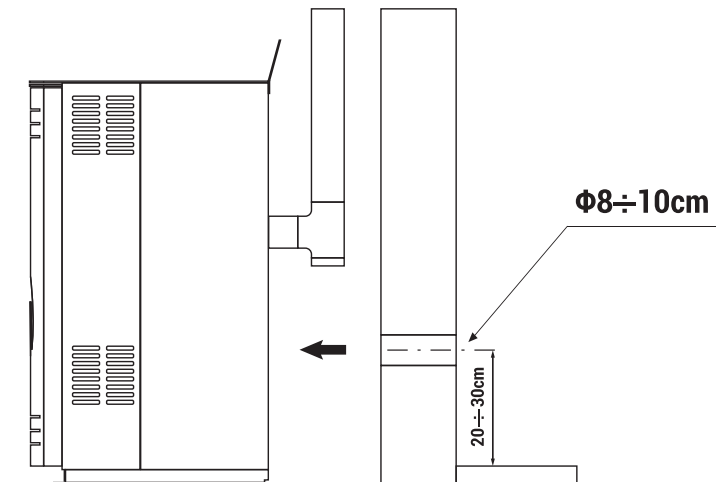

### 3.4. Connecting to the electrical system.

The pellet stove is complete with a power cable, through which it is connected to a 230V, 50Hz electric network. Deviations of these values by more than 10% may result in damage to the equipment. The power grid must comply with grounding norms. According to the requirements for connection to the mains, the installation of the fireplace should ensure free access to the plug and the socket. Lack of grounding / grounding can cause damage for which the manufacturer is not responsible.

### 3.5. Connecting to the heating system.



**ATTENTION! The connection of the fireplace to the water heating system shall only be carried out by an authorized installer and in accordance with the applicable legal provisions!**

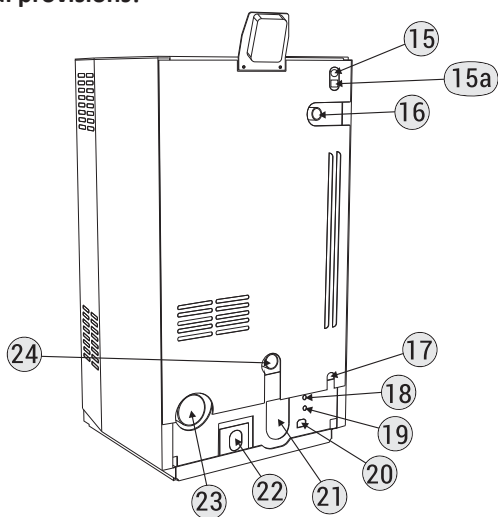

15	Room thermostat coupling
15a	Thermal protection for water overheating
16	Water outlet
17	Exit safety valve
18	Fuse 0,8A
19	Fuse 5A
20	Power supply
21	Pump
22	Water inlet
23	Chimney
24	Fresh air inlet

#### 4. Used fuel.

For used fuel are recommended wood grade pellets class EN plus A1, according to EN14961:2011 with diameter 6-8 mm. When using fuel non-compliant to the European directive, the manufacturer is not responsible for the incorrect operation of the equipment! Ask your pellet supplier for proper storage. Read the instructions on the label!

Table: European wood pellet certificate

Parameters	Measuring units	ENplus-A1	ENplus-A2	EN-B
Diameter	mm	6 (± 1) 8 (± 1)	6 (± 1) 8 (± 1)	6 (± 1) 8 (± 1)
Length	mm	15≤L≤40 1)	15≤L≤40 1)	15≤L≤40 1)
Bulk density	kg/m <sup>2</sup>	≥600	≥600	≥600
Calorific	MJ/kg	≥16.5-19	≥16.3-19	≥16.0-19
Humidity	Ma .-%	≤10	≤10	≤10
Dust	Ma .-%	≤1 3)	≤1 3)	≤1 3)
Mechanical strength	Ma .-%	≥97.5 4)	≥97.5 4)	≥96.5 4)
Ashes	Ma .-% 2)	≤0.7	≤1.5	≤3.5
Chlorine content	°C	≥1200	≥1100	-
Sulfur content	Ma .-% 2)	≤0.02	≤0.02	≤0.03
Nitrogen content	Ma .-% 2)	≤0.03	≤0.03	≤0.04
Copper content	Ma .-% 2)	≤0.3	≤0.3	≤1.0
Chromium content	Ma .-% 2)	≤10	≤10	≤10
Arsenic content	Ma .-% 2)	≤10	≤10	≤10
Cadmium content	Ma .-% 2)	≤1.0	≤1.0	≤1.0
Chromium content	Ma .-% 2)	≤0.5	≤0.5	≤0.5
Mercury content	Ma .-% 2)	≤0.1	≤0.1	≤0.1
Lead content	Ma .-% 2)	≤10	≤10	≤10
Nickel content	Ma .-% 2)	≤10	≤10	≤10
Zinc content	Ma .-% 2)	≤100	≤100	≤100

The maximum capacity of the pellet hopper on the Bijou fireplace is 45 kg (3 sacks x 15 kg).

## 5. Operation of the Bijou pellet fireplace.

### 5.1. Safety measures.

Pellet fireplace Bijou is a facility that develops high temperatures. There is a risk when in contact with heated surfaces:

- Fire hazard. Keep flammable objects and liquids away from the facility!
- Do not pour the unit with liquid!
- Do not leave children and people with disabilities unattended near the facility!

### 5.2. Switch on the fireplace:

- Make sure the controller settings are correct;
- Make sure that the appliance is correctly connected to the mains and the heating system;
- Turn on the fireplace.

## 6. Work on the Bijou pellet fireplace controller

### WORK OF THE CONTROLLER

The fireplace, run by NPBC-V3C-G2, can work in both continuous mode and timer mode. When in timer mode, the fireplace works only at user-defined intervals and days of the week. In operation, it goes through several phases: cleaning, ignition, fire stabilization, combustion with power modulation depending on the current and set boiler temperature, intermediate cleaning performed during the combustion process, extinguishing and cleaning after burning. A green text at the bottom line of the main screen shows at what stage is the current fireplace process.

Each ignition of the fireplace starts with a cleaning cycle. The purpose is to remove all residues from previous combustion. First for a specific time set in the menu „**Service settings**“ -> „**Burning setup**“ -> „**Fuel X**“ -> „**Cleaning**“ Fan column row „**Start**“, only the main fan works, then the auxiliary cleaning fan, if any, is switched on and is not switched off by the time settings set on the column „**FC**“. Then the fireplace goes into the ignition phase.

The procedure for ignition of the fireplace starts with the first load of pellets in the combustion chamber. This is done with the help of an electric heater and forced air from the fans of the fireplace. The ignition procedure is performed after loading the first pellet dose and consists of three stages. During the first stage only the electric heater works so that the required ignition temperature can be reached more quickly. During the next two stages, the air supply to the combustion chamber starts simultaneously with the operation of the heater, which transfers the heat of the heater to the pellets and supplies the necessary oxygen to ignite the fuel. After a firmer heat is build-up, the amount of air can be adjusted, which can be done during Stage 3. From the menu „**Service settings**“ -> „**Burning setup**“ -> „**Fuel X**“ -> „**Ignition**“ adjusts the maximum duration of each ignition stage and the fan speed. When the pellets are ignited, they will start to raise the temperature of the exhaust gases. With the thermosensor type pt100 the controller measures the temperature of the exhaust gases. If the difference between the flue gas temperature and that of the water in the fireplace becomes greater than the limit set in the menu: „**Service settings**“ -> „**Flame detection**“ the line with a red flame, it is judged that the pellets are ignited. Then the heater is switched off and a burning procedure is set to stabilize the fire until the combustion chamber is still not hot enough. If the pellets are not lit within the set time, the burner is charged with a new batch of pellets and a new ignition attempt is made. In order not to clog the pellet burner with non-lit pellets, the amount of new pellets supplied reduces twice in each subsequent ignition attempt. In addition, new pellets are only given for the first 3 firing attempts at 100%, 50% and 25% of the set quantity. When the maximum number of attempted ignition attempts is reached, the firebox stops by displaying a failed ignition message. The parameters required to control the charge with the first dose of pellets and their ignition are in the menu: „**Service settings**“ -> „**Burning setup**“ -> „**Fuel X**“ -> „**Ignition**“.

The next phase of the fireplace's work is the procedures for a calm ignition of the fire. If, at an unstable flame and a cold combustion chamber, a pellet and air supply for maximum power starts, the flame may be suffocated. To avoid this, first awaiting the proper burning of the first dose of pellets and then gradually increasing the power. The setting of the burning process is done in the menu: „**Service settings**“ -> „**Burning setup**“ -> „**Fuel X**“ -> „**Unfolding fire**“.

The next step is combustion management. The controller supports settings for 4 different capacities. Three of these capacities are used during the normal operation of the fireplace. The fourth power is to maintain the fire when there is no need to heat the water, thus avoiding the need to quench the fireplace, then clean it and fuse again. Of course, if there is no need for new energy in the heating system for a long time, the fireplace will be extinguished.

The dose of pellets to be fed into the combustion chamber and which determines the current power is in function of: fuel capacity, feed time, and cycle between two auger connections. The parameters needed to adjust each power are: the fuel feeder operation time, the cycle between two consecutive feed times and the main and chimney fan speeds. They are set in the menu „**Service settings**“ -> „**Burning setup**“ -> „**Fuel X**“ -> „**Power P1** “/„ **Power P27**„**Power P37** “**Maintaining**“. The fireplace automatically selects how much power to operate depending on the temperature difference between the set and the current temperatures. The selection is made at the beginning of each fuel cycle. All this is tuned by „**Sercive settings**“ -> „**Power** “. The last menu also adjusts the maximum time that the fireplace will have fire power. If that time runs out the fireplace will go out. If, during the “**Maintaining**” phase, the temperature difference reaches that required for some of the operating capacities, it will ignite again using the embers inside it, not the heater.

When the fireplace is switched off, whether from the **On / Off** button or from the timer, it immediately goes to an operational phase of extinguishing. For this purpose, the fuel supply is stopped and the fan continues to work to completely burn the remaining pellets. Then the current temperature is continuously measured and the temperature and temperature difference of the fireplace is calculated. If the temperature drop is higher than the temperature set in the menu: „**Sercive settings** “ -> „**Flame detection**“ the line with the white flame is judged that the fire is extinguished. Then the fireplace passes to the cleaning stage, then goes to baseline. If the exhaust gas temperature does not drop with the set degrees for a longer period of time set in the same menu on row „**Extinguishing time max [min]**“, the controller will decide that the fire has extinguished regardless of the measured values.

The burner is cleaned up to 100% fan speed and if there is an additional powerful blower or other mechanical cleaning system to the FC outlet and with them. The cleaning settings vary, depending on whether it is before firing, after extinguishing or when there is a problem. The procedure is as follows:

1. The fireplace is extinguished and waiting for the fire to go out.
2. Turn on the main fan and operate at the maximum power set by the menu „**Service settings**“ -> „**Burning setup**“ -> „**Fuel X**“ -> „**Cleaning**“ Fan column row „**Start**“, „**Stop**“ or „**Alarm**“.
3. Upon expiration of the time from the above step, an additional more powerful fan or mechanical cleaning system may be included which work together with the main fan for a time set by the menu „**Service settings**“-> „**Burning setup**“ -> „**Fuel X**“ -> „**Cleaning**“ column „**FC**“ row „**Start**“, „**Stop**“ or „**Alarm**“. If time 0 is entered, FC output will not work and this step is skipped!

Except when igniting, extinguishing or a registered alarm, the controller allows setting of additional automatic cleaning cycles. Enable automatic cleaning and fireworks timing for this cleaning is set in menu „**Service settings**“ -> „**Burning setup**“ -> „**Fuel X**“ -> „**Cleaning**“. During automatic cleaning, the fireplace is first extinguished, cleaned and then re-ignited automatically.

The controller uses another method of intermediate cleaning, in which the fire is not extinguished, but only the fan power is increased or the output FC is triggered for some mechanical mechanism for cleaning. The required settings for this cleaning method are made from the menu „**Service settings**“ -> „**Burning setup**“ -> „**Fuel X**“ -> „**Interm cleaning**“. The parameters to be set are: the time that the intermediate cleaning procedure repeats, the fan speed to be maintained during cleaning, how long to clean and whether to use the FC output. During this cleaning method, pellet feeding is not interrupted.

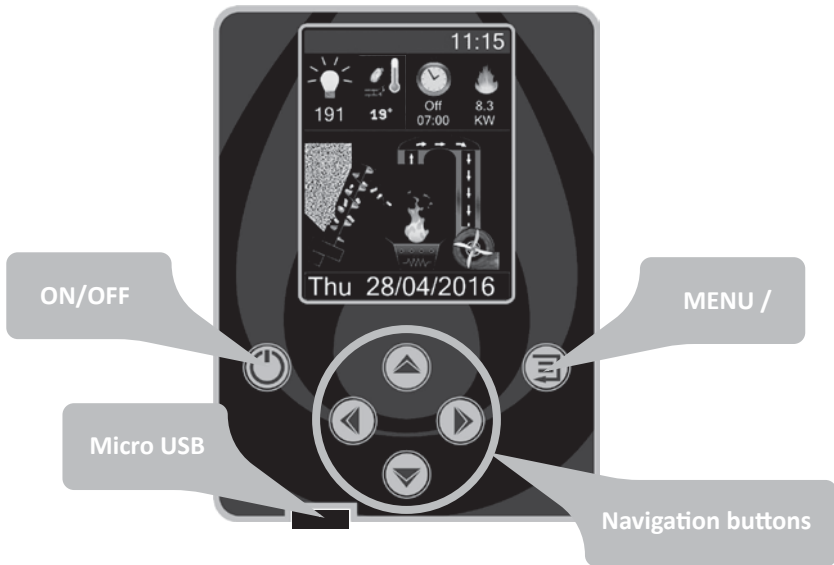

After the power is turned on, the controller displays its main screen, which has the following view:

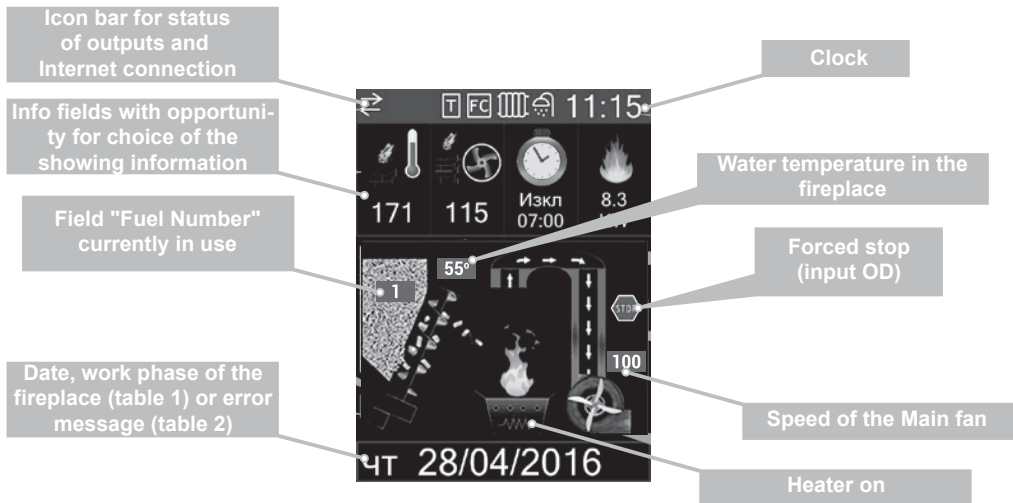

During the operation of the fireplace, the operation of the feeder and the fan is displayed with animated pictures in their respective place. When a fire is registered, a flame will appear. If several messages are required to be displayed on the bottom line, they alternate in 4 seconds. The date is displayed in white, the working phase is green, and the errors are red. Showing the date can be limited by **User settings -> Display -> Show date**

If the watch has not been set, its indication will be --:-- . For the normal operation of the fireplace you will have to adjust the clock.

In most cases, when there are reports of errors displayed in red on the bottom line, a three-tone warning beep will be heard.

Some error messages are automatically cleared after the reason for the registration has disappeared. There are other messages such as "Reverse burning", "Freezing" and so on, which can be cleared by pressing and holding the button ◀ for more than 2 seconds.

Selective information fields can be from the following list:



Chimney Fan Speed



Displays information about the next timer action. If the timers are not activated or the fireplace is turned on, there will be no information below the icon. If at least one timer is active and the burner is on, the next timer action will be below the timer and the time or day of the week when it will happen.



Calculated power of the fireplace at the moment. For this power to be credible you need to enter a calibration constant for the feeder from „**Service settings**“ -> „**General settings**“ -> „**Feeder capacity**“.



Temperature measured by the thermosensor for DHW.



Temperature, measured by the flue gas temperature sensor.



Time remaining until the end of the procedure.

Icons in the top blue strip:

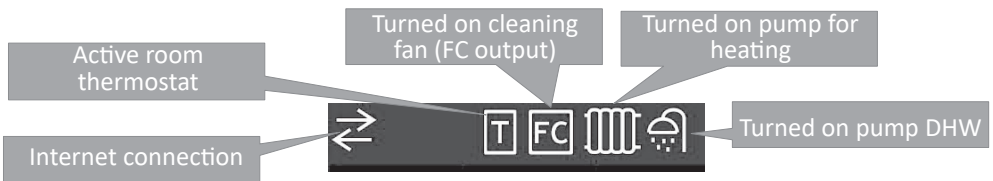

### Switching the burner on / off:

By pressing the **On / Off** button switches to the On, Off, or Timer menu.

Press the "▲" or "▼" buttons to move up or down the red marker line indicating which fuel is selected for "On" or "Off" mode. The next time you press the On / Off button, it switches to the selected mode. If a button is pressed for more than 5 seconds or not pressed, the mode or status changes.

To make sure that the fireplace is turned off, you need to make sure that at the bottom line does not appear a green text, with some of the operating phases of the fireplace listed in Table 1.

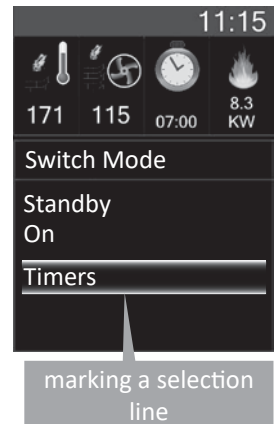

No	WORK PHASES	No	WORK PHASES
1	Cleaning	6	Power P1
2	Feeding	7	Power P2
3	Ignition	8	Power P3
4	Burning	9	Intermediate cleaning
5	Supporting	10	Extinguishing

**Table 1**

When the fireplace is in the "Off" mode, it will not work. If the burner has been switched on when switching to this mode, it will switch to the fire extinguishing procedure. Complete extinguishment of the fire and cleaning require some time. It is normal for the stove units to continue working after switching to the "Off" mode. Circulating pumps can continue to operate despite the burner that has been extinguished while the conditions for their operation are met. In this way, the remaining heat of the water in the fireplace will be used.

To switch to "On" mode, we must have previously selected the fuel settings and the fuel number. This is done from custom settings „User settings“ -> „Select fuel“ -> „Fuel X“. If all ignition conditions are met, such as not reached fireplace temperature, room thermostat not activated, absence of registered serious problems and permission if one of the timers is switched on, the fireplace will automatically switch to ignition. Then all the set ignition procedures, fire stabilization, maintenance, power modulation, intermediate cleaning, extinguishing and complete cleaning for that fuel will be automatically executed.

### **Changing the temperature of the water heater**

By pressing buttons “▲” or “▼” when the controller is in the "Main screen", it switches to the adjusted temperature adjustment screen. The temperature will begin to change when you release the pressed button and then press it again. If any of the ▲ or ▼ buttons hold, the temperature will automatically increase to a speed of up to 5 degrees per second. To exit and store the temperature, press the **(Menu)** button. If you do not press a button for 5 seconds, it will go to the main screen and the change will not be saved.

## Provide additional information on the operation of the fireplace.

By pressing a button when the controller is in the "Main Screen", it goes to viewing the additional information screens.

### Statistics of pellet consumption by hours.

The first information is the "Pellet consumption" screen that contains pellet consumption graphs for the last 4 days. First, information about the current day is displayed, and the buttons "▲" or "▼" are used to go to the next up to 4 days. The output is done with a histogram on the entire display. The coordinate system has a horizontal axis with the hours and a vertical axis with the pellets consumed in kilograms for the respective hour. The top date is the date to which the information relates, and at the bottom is the summary information on the consumption of pellets during the day.

### Status information for some current parameters.

By pressing the "▶" button when the controller is in the "Pellet consumption" screen, it switches to the screen "Information".

This temperature display shows the domestic hot water (DHW) temperature, the current chimney fan speed, the exhaust temperature, and the pellet consumption since its last reset.

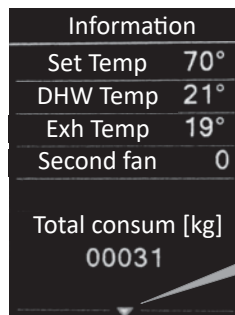
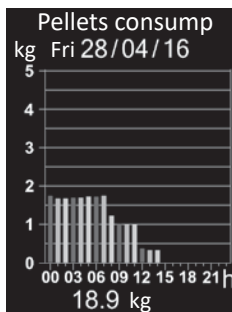
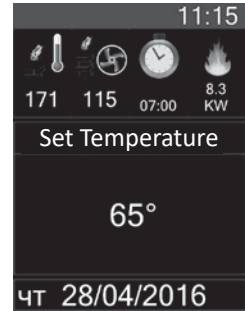

A sign that there are more rows down

By pressing and holding the Menu button for more than 2 seconds, the total fuel consumption readings are reset. It also remembers the date and time of this reset, which will give you information about what time period the next "total cost" of pellets has been accumulating. Keep in mind that the pellet consumption for the current day is not reset because it starts counting from 00:00 hour of the day whose date is displayed on the screen!

If in the "Information screen" is pressed "◀", it switches to the front screen - „Pellet consumption".

In addition to these measured parameters, there are other items important to the fireplace, which can be output for permanent observation in the Information Box on the main screen.

Information about WiFi modem operation and internet connection.

To get to the "WiFi connections" screen, press the "T" button.

The fields are as follows:

- \* **ID** - Unique identifier for each modem
- \* **IP** - IP address of the modem
- \* **WiFi mode** - Modem status that can be:
  - \* **Idle** - The modem has not yet connected to a WiFi router with Inernet
  - \* **Access point** - The modem is in the Access point mode and provides the ability to accept a SSID and password on the local WiFi network to connect to it
  - \* **AP Associated** - The modem has been connected to the router
  - \* **Internet Access** - There is an Internet connection
  - \* **Connected** - The modem has been connected to the information system server
  - \* **Snd/Rcv** - Sent / received data packets over the Internet If there is no WiFi modem connected to the controller, there will be a message "No WiFi modem".



### Version of the controller and the software in it and version of the software in the WiFi modem NRM-W3

To get to the version screen, press a button from the screen „WiFi connections".

## Diagnostics

By pressing a button "▶" when the controller is in the Information screen, you switch to the Diagnostics screen, which is a list of information about each registered problem and the exact time and date of its occurrence. If they are more than 4, the "▼" or "▲" buttons respectively show the next or previous page. Holding the Menu button for more than 2 seconds clears the accumulated diagnostic information.

The star symbol marks the last and most recent registered information. The messages you can see on this screen are shown in Table 2. Messages 1 to 13 are also displayed as registered damage messages at the bottom line of the main screen.

Diagnostics	
★	28/04/16 14:58
Menu settings	
	28/04/16 14:52
	Off PT Sensor
	28/04/16 13:20
	Off WH Sensor
	28/04/16 11:39
	Off boiler TS

No	Message	Clearing the error	Description
1	Reverse burning	With button "◀"	A "burn-back" thermostat has worked
2	Interrupted TC boiler	Automatically	Disconnect sensory of the fireplace
3	TC short circuit	Automatically	Short in the thermosensor of the fireplace
4	Frozen boiler	With button "◀"	Time and date when a situation for a frozen boiler is recorded
5	Unsuccessful ignitioning	With button "◀"	
6	Interrupted TC RB	Automatically	Disconnect thermosensor for back burning
7	Short circuit TC RB	Automatically	Short on the back burner (if a thermosensor is used)
8	Interrupted TC boiler	Automatically	Interrupted thermosensor of the DHW cylinder
9	TC short circuit	Automatically	Short in the DHW cylinder thermostat
10	Interrupted TC pt100	Automatically	Interrupted thermosensor for flue gas type pt100
11	TC pt100 short circuit	Automatically	Short in the flue gas sensor type pt100
12	High smoke temperature	With button "◀"	The temperature of the exhaust gases is very high
13	Dangerous smoke temperature	With button "◀"	The temperature of the exhaust gases is unacceptably high
14	Settings menu	-	Entered the system setup menus
15	No used module	-	Missing link to "Executive Module"
16	Turn on the power	-	Time and date when controller was running before the power went off
17	Turn off the power	-	Time and date while the controller was running before the power went off
18	Start	-	First record after restarting the controller or deleting the diagnostic buffer

Table 2

If from the "Diagnostics" screen, " ◀ " is pressed, it switches to the front screen - "Information".

When the error messages are red in the lower field of the main screen, they can be cleared in the following ways:

- Automatically after dropping the cause that caused them to appear for all messages with auto-clearing enabled;
- by pressing and holding the " ◀ " button for more than 2 seconds until the display is in the main screen and when the cause of the display is dropped

### **Automatically displayed warning messages.**

In some cases, screens with red warning "Attention!" and a message with a reason for appearing can be displayed, for example the screens below:

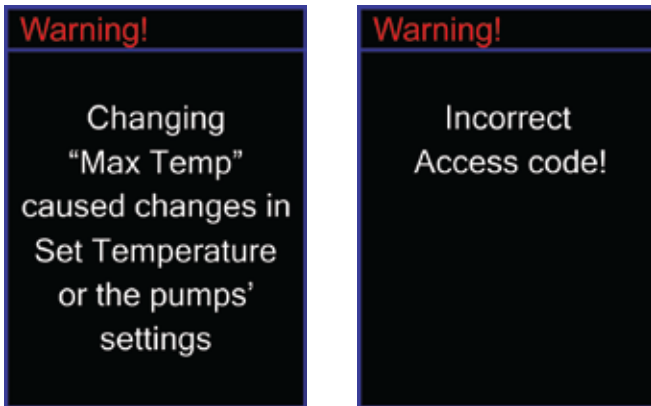

### **Setting the operating parameters.**

There are two sets of parameters in the NPBC-V3C-G2 controller that can be set with different access restrictions: "User" and "Service". To enter the user parameter setting mode, you must briefly press the Menu button. To set the service parameters, press and hold the Menu button for at least 2 seconds and then enter an access code if necessary.

### **Ways to change operating parameters.**

When setting the parameters required for the controller, the display is similar to some of the following views:

\* Select from list - The red line indicates the highlighted line. Use the "▲" or "▼" buttons to move the red line. By pressing the "▶" button, you select the option of the highlighted line by entering the corresponding setting screen. If there are more rows below the visible part of the screen there will be an arrow pointing down. If there are more rows above the visible part of the screen, there will be an arrow pointing upwards. If there is an arrow to the right of the row, then you will not enter the setup screen, but to the submenu. If an additional submenu is currently being considered, pressing the button "◀" switches to the previous selection menu.

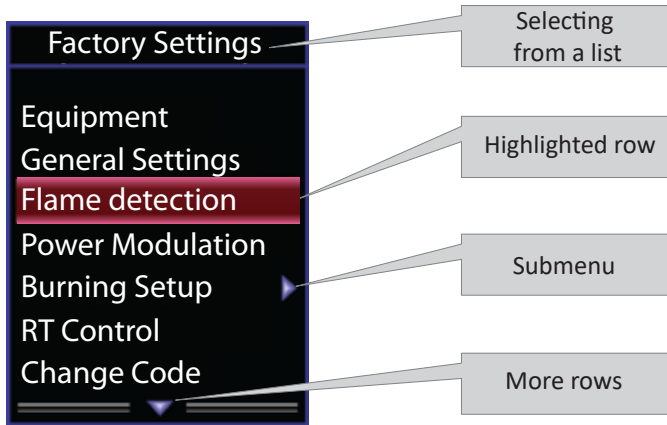

**Setup screen** - After entering this screen, a pink markup frame is displayed on the first parameter, indicating that this parameter can be edited. You can use the "◀" or "▶" buttons to position the marker frame on the parameter you want to edit, respectively moving left / right or up / down.

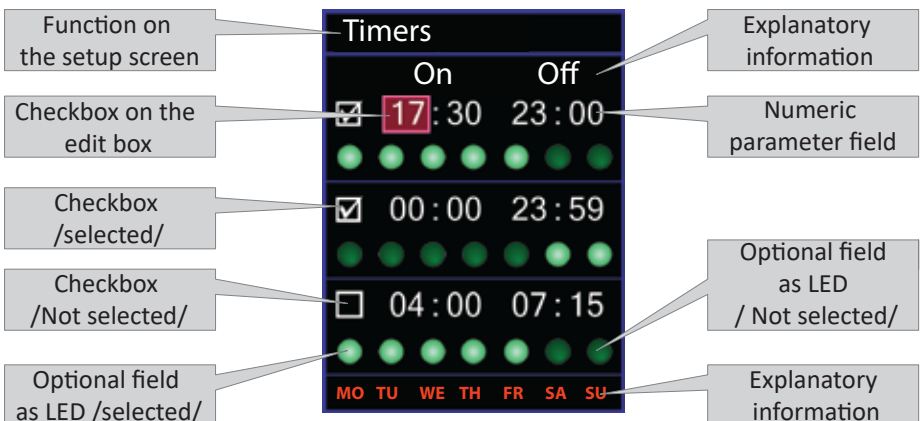

With buttons "▲" or "▼" The marked parameter can be changed as its value increases or decreases respectively or selects or releases. The parameter fields are some of the following types: numeric parameters, selection fields with possible values activated / not activated Selected / unselected) or a list of text values. Numeric parameters are checked for acceptable limit values and if they are reached, the corresponding parameter stops changing despite the short beep sound when pressing the change button.

After completing the necessary adjustments to memorize the changed parameters and exit to the previous screen, press the **(Menu)** button. The maximum wait time is provided without a pressed button, after which it goes to the previous screen without remembering the changes made so far.

When you hold down one of the arrow buttons, in most cases there is an automatic repeat of the function of the respective button. This repetition is at a rate of 5 times per second, which will increase or decrease the value of the selected parameter or move the marker frame between the individual parameters!

### User parameter settings.

When the main screen is displayed, pressing the **Menu** button briefly enters the screen for selecting a set of parameters for editing. Use the "▲" or "▼" buttons to move the red line. By pressing the "▶" button, the group of settings is selected from the highlighted line entering the corresponding setup screen. Then work in the way described below:

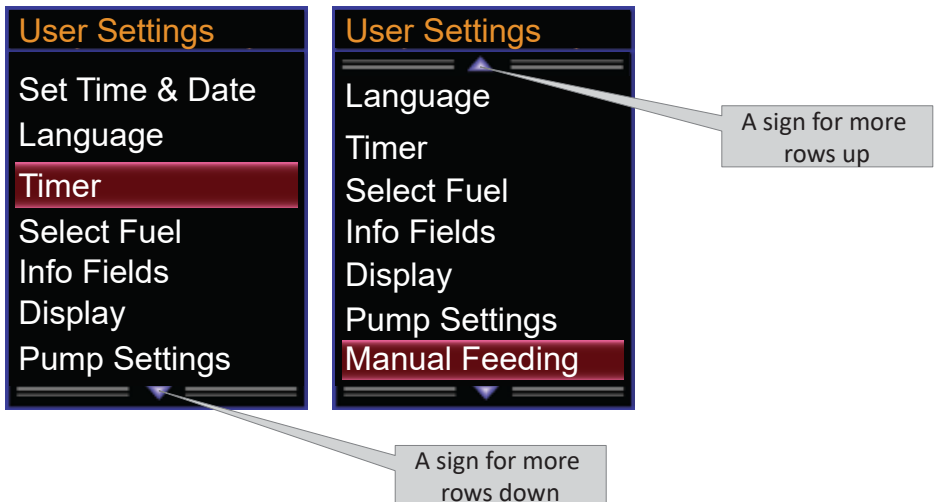

Time and date - Configuring the clock on the controller. The time is 23:59 and the date is dd / mm / yy. The day of the week is automatically received after entering a correct date. If you change the time or minutes after exit, the seconds are automatically reset. With a date-only change, the seconds are not reset. In order for automatic time control to work, the controller will need to have a modem and a connection to Naturela's Web Browser information system.

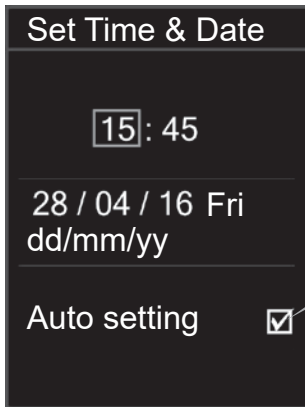

The clock will be automatically adjusted if there is a WiFi and an Internet connection

The clock will be automatically adjusted if there is a WiFi and an Internet connection



**Language** - Change of language

Use the "▲" or "▼" buttons to move the red line to select the language, press the "▶" or Menu button to select the language, then move to the main menu to select but already with a changed language. If there is an arrow down or the first row has an up arrow after the last row, it means there are more rows not shown on the screen. Pressing the up or down arrows will move the screen up or down respectively to show the next rows.

**Timers** - Set and activate hourly intervals in which fireplace operation is allowed. If at least one of the three timers is active, it will work only at the intervals indicated by the active timers! Out of the intervals will be extinguished.

When checked, timer is active its hourly interval will be used

Choose which days of the week to use the time interval of the corresponding timer: when LED is on - to be used when LED is off - will not be used

Days of the week

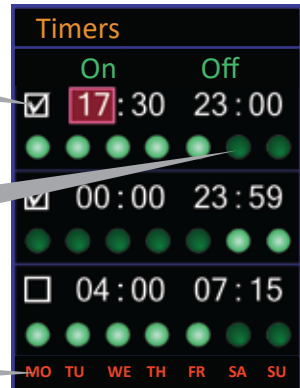

Keep in mind that the time in the "On" column can not be greater than the time in the "Off" column! Entering such values is impossible, so you may need to change the time in the "Off" column first and then in the "On" column!

To see more clearly whether the timers are activated, control the fireplace's next on / off action, and how many hours you can output the information from them in the data fields at the top of the screen.

If there are active timers and the fireplace is turned on by pressing and holding the On / Off button for more than 2 seconds, the timers will be turned off.

**Info Fields** - Sets the information to be displayed in the four data fields at the top of the screen.

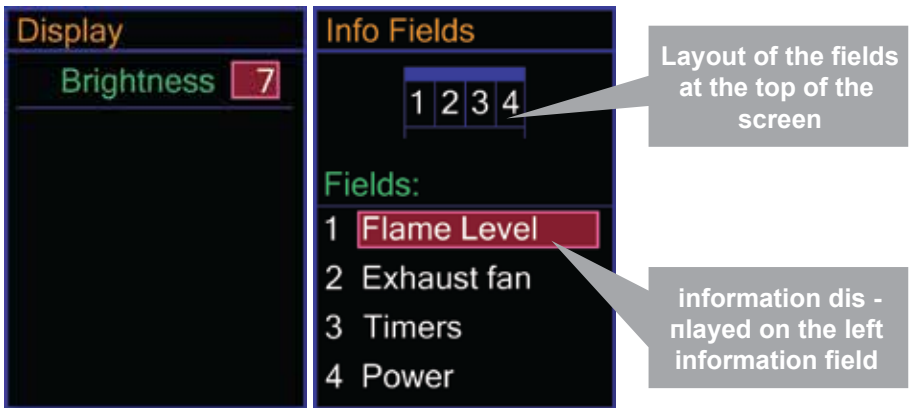

The possible captions and output information in each field are as follows:

- **Add. vent.** - chimney fan speed
- **Timers** - next action controlled by the timers
- **Power** - calculated instantaneous power produced by burning the pellets
- **Temp HWT** - temperature of the hot water tank
- **Temp gas** - exhaust gas temperature

**Display** - Brightness field changes the brightness of the display. NRC-6 does not automatically shade the screen.

**Pump settings** - sets the operating mode of the pumps of the outdoor heating systems as well as their switching on and switching off temperatures. The pumps are as follows: a heating system pump connected to PH outlet and pump for domestic hot water boiler connected to PWH outlet.

The "Pump operation" field may have the following values:

- **Heating priority** - only the heating installation of the building will be used. The circulation pump of the heating system will be switched on when the temperature of the water in the fireplace reaches the temperature set in the heating installation area. The pump will continue to operate until the water temperature drops below the temperature of line „Turn on" minus the „Hysteresis“. When the room thermostat is operating as a result of reaching the set temperature, the pump continues to operate, but the stove will start to decrease its power down one step down at certain time intervals that are set in the menu „Service settings" -> „RT Control". Finally it will pass through power „Suspend". If the room thermostat returns to its normal state before the fireplace goes off, it will continue to operate according to the temperature of the water in the fireplace. If the room thermostat has worked for a longer period (all times have elapsed since „RT Control" + the time from "Suspend" from the menu „Factory settings" -> „Power modulation"), the fireplace will be extinguished and will be re-ignited after the thermostat is restored and provided that the temperature of the water in the fireplace is below the set temperature minus the temperature difference for switching from second to first power (value of P2 in menu „Factory settings" -> „Power modulation").

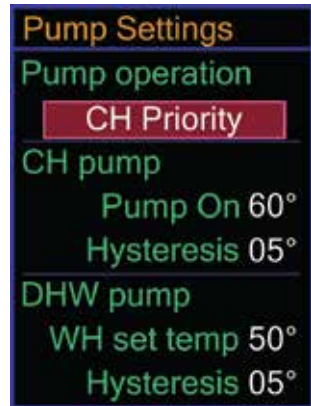

- **DHW Priority** - the domestic hot water tank (DHW) is preheated. The pump in the boiler installation will switch on when the following conditions are met:

- \* The temperature of the water in the fireplace is over 35 °C
- \* The difference between the water temperatures in the stove and the boiler is above 5 °C
- \* The water temperature in the boiler is lower than the temperature, set in the DHW installation area „Temp DHW“.

Once the set temperature has been reached, the circulation pump will stop and will switch on again when the water temperature in the boiler becomes lower than the difference „Temp DHW“ - „Hysteresis" from the DHW installation area. To ensure that the boiler is heated as quickly as possible while the pump is running, the circulation pump on the heating system needs to be stopped. If there is a room thermostat from the menu „Factory settings" -> „Equipment“, „Room thermostat“. Then in case the thermostat is running, the circulation pump of the heating system stops.

In addition, if the boiler water is hotter than „DHW Temperature" - „Hysteresis", the fireplace will go to the power state „Suspend". If the room thermostat is restored or the boiler temperature falls, then the burner returns to normal operating mode according to the temperature in the fireplace. However, if the situation does not change, the burner will switch off after the time allowed for the fire to be maintained. It will re-start when the water temperature drops below the set temperature minus the temperature difference for switching from second to first power (the value of line P2 in the menu „Factory settings" ->„Power modulation"). If the room thermostat is activated, then, in addition to the above condition, either the thermostat is not selected or the boiler temperature drops below the set hysteresis.

\* If there is no room thermostat activated, it will be assumed that the room temperature is not reached and the heating pump will operate unconditionally!

- **Heating + DHW** - both installations will operate: heating and hot water. The operation of the fireplace and the pumps is analogous to mode "DHW priority" except that the circulating heating pump can operate at the same time as the DHW circulation pump.

- **Summer mode** - the fireplace will only work to heat the domestic hot water tank. The difference between this setting and "DHW priority" is that the fireplace ignites only when there is a need to heat the boiler and when it heats the fireplace is extinguished. In this mode, the heating system will not be controlled..

- **Manual feeding** – Manual turning on the fuel feeder or circulating pumps. This menu will be useful for: filling the feeder when it is empty, turning on the feeder to measure the amount of pellets delivered per unit of time for calibration, switching the circulating pumps for test or filling up their water installation. As with all other button menus "▲" or "▼", the selection box is selected or cleared to enable or disable the corresponding output. Use the "◀" or "▶" buttons to position the marker square on the desired output.

Setting the feeder operating time

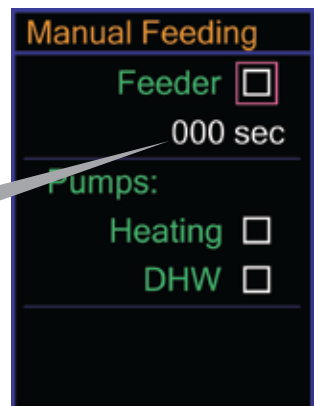

The maximum time of the "**Manual feeding**" mode without pressing any button is about 6 minutes.

Then all outputs are turned off and the previous screen is shown. This mode can be used to calibrate the feeder by first filling it and then switching on for some time, for example 3 minutes as the pellets during this period will fall into some large enough vessel. Then you have to measure the weight of the pellets that have been collected and the number is multiplied by 20. So you will get how many kilograms of pellets fall an hour from the "**feeder capacity**".

**New WiFi network** - If the NRC-6 has an WiFi Internet Connection Module, and if it is installed for the first time or needs to change the WiFi network to which it is connected in, it must go through this menu.

By pressing the "▼" button, the module will switch to the **Access point** mode by displaying the screen below, then you will be able to enter the name of the new network, password, and encoding mode. Pressing the **(Menu)** button will exit this function without changing the modem status.

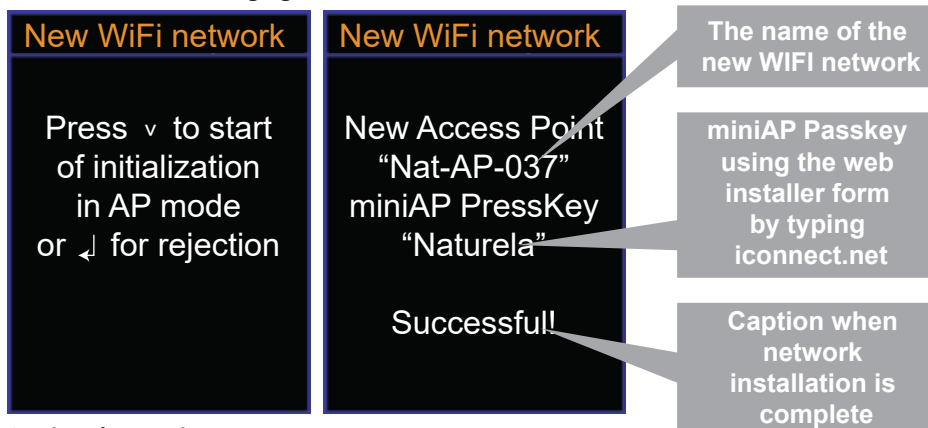

#### Setting the service parameters.

These parameters have a direct regard on the management of the burning, combustion and fire safety of the fireplace. For this reason, it is possible to restrict access to all submenus under this section with an access code requirement. The access code is set from the menu „**Factory settings**“ -> „**Change code**“, and an access code request may also be disabled from the same menu. To access the Service Parameters menu, press and hold the "**Menu**" button for more than 2 seconds. If the personal code request is enabled, the screen below will appear.

You can use the "▲" or "▼" buttons to enter the exact value of the current digit, or all the digits are scrolled with or buttons. To confirm the entered code, press **(Menu)**.

After a correct access code is entered, a screen for selecting the service settings menus will appear. Keep in mind that the NPBC-V3C-G2 controller supports up to 4 different profiles for different fuels. Some of the settings do not depend on the fuel you are working with and are common to all fuels. However, there are many parameters that depend on the fuel for which they are designed, and therefore one must first choose one of the fuels. Fuels have names: **Fuel1, Fuel2, Fuel3 and Fuel4**. When there is a right arrow next to the selection line, a submenu will be shown:

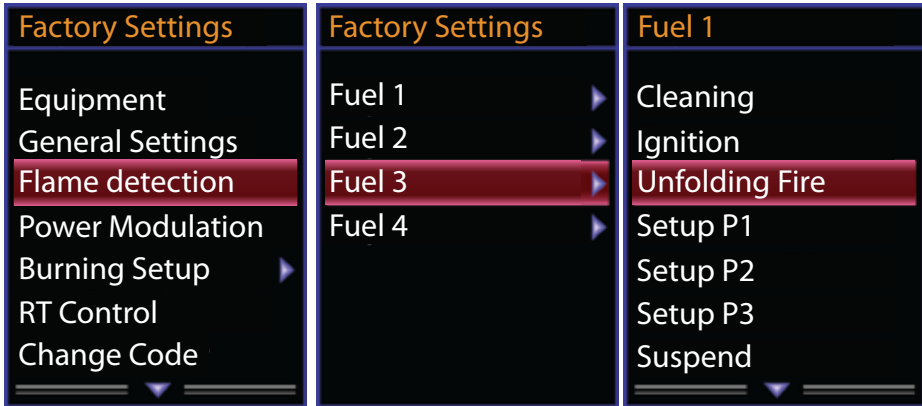

Hierarchically arranged selection menus, with arrows or "◀", you can browse subordinate or previous menus.

### Service settings not dependent on fuel.



There is a vacuum sensor

Room thermostat with normally open circuit

**Equipment** - this menu adjusts the presence or absence of the optional components of the fireplace as well as the polarity of the operation of the contacts of the room thermostat or the forced stop circuit connected to input OD.



**Main settings** - here are set the maximum allowed heating temperature of the stove and the capacity of the fuel feeder.

General Settings	
Max Temp	80°
Feeder capacity [kg/h]	8.2

**Flame detection** - Adjust what is the increase or decrease of the exhaust gas temperature relative to that of the water system. Here is also set the maximum waiting time for the fire to go out after shutting down the pellet. After this interval, the fire will be considered to be extinguished.

The fire will be considered lit if the temperature of the exhaust gases rises by 5 degrees to that of the water system.

The fire will be considered extinguished if the exhaust gas temperature is equal to that of the water system.

Flame detection	
Exhaust gases temperature	
	05° higher
	00° lower
Exhausting time max [min]	12

**Modulation power.** - Adjust the temperature differences between the set and measured temperature of the stove, when they are switched from one power to another. Also set the operating conditions for the "Suspend" state, the time of waiting and the maximum overheating of the temperature, before switching off.

After the temperature is higher than the set for P1 the fireplace will switch to "Suspend" mode.

If the temperature of the fireplace is higher than the set +8°, even if the stopping time is not over, the fireplace will turn off.

Power Modulation	
Power Level	
P3 ΔT>	10°
P2 ΔT>	05°
P1 ΔT>	00°
Suspend mode	
Duration [min]	20
Overheating	08°

When the difference between the set and the measured temperature is above 10° will work on power P3

The fireplace will operate at a power of P2 at a difference between 5° and 10°

**RT Control** - Here is how the power of the fireplace is reduced when it works the room thermostat and the pumps are in the mode „Heating priority" In this mode, once the room thermostat has worked, if the stove has been operating at power P3, for example, it will hold at this power the set time below and then switch to power P2, P1 and „Suspend". Suspend power will last as long as it is set in the menu „Service settings" -> „Power modulation" „Time". These settings are responsible for the gradual decrease of the power supply to the heating system when reaching the expected room temperature.

60 seconds after start of the room thermostat work, the fireplace will continue to work on Power P3.

More 60 seconds on Power P2 and so on.

When the temperature of the exhaust gases reach above 200 °, the display will show alarm.

When the temperature of the exhaust gases reach above 220 °, the fireplace will go out.

**Safety setup** - If a thermosensor for the flue gas temperature is installed, it can be used to output an alarm or fire extinguishing when the temperatures set in this menu are exceeded.

**Change code** - Allows or prohibits the use of access code to the service settings menus. The code consists only numbers. From the security point of view, only the figure that changes will be visible.

*If a code is allowed on this menu entry, you must enter a new code, otherwise the permission will not be executed!*

If check is marked before entering in "Service settings" will ask access code .

Change Code

Use code

New code:

0 \* \* \* \* \*

Repeat:

\* \* \* \* \*

*Not all digits may be entered, but when repeating and entering the access code you will not need to enter it the same way!*

**Output Test** - Through this menu, all outputs of the controller can be directly controlled. In order for this control to be possible, the fireplace should be switched off. Maximum activity time of this menu is provided without pressing buttons of 5 minutes. The outputs then turn off and previous screen is shown.

When output FM is different than 0, it will be powered up.

In case of marked output field SB will be powered.

**Output Test**

FM	0	FSG	0
SF	<input type="checkbox"/>	SB	<input type="checkbox"/>
PT	<input type="checkbox"/>	PWH	<input type="checkbox"/>
IGN	<input type="checkbox"/>	FC	<input type="checkbox"/>

**Fuel-dependent service settings**

To access these settings, you must go to the main service settings screen on line „**Burning setup**”, press the button “▶”, then select fuel and press the button “▶”.

**Cleaning** - This menu sets the length of the cleaning cycles, with the operating time of the main and auxiliary cleaning fan. Here you can set whether to have automatic cleaning cycles and how long they will be. The automatic cleaning cycles are in the following sequence: extinguishing, cleaning after extinguishing and re-firing. Cleaning procedures are performed before ignition (line Start), after extinguishing or during automatic cleaning (line Stop) and when an alarm is registered „Reverse burning” (line Alarm).

Number of fuel 1

Column with settings for the working time of fan on 100%.

The burner will be automatically cleaned during operation for 120 minutes

**F1> Cleaning**

Stage	Fan Sec	FC Sec
Start	180	0
Stop	180	0
Alarm	180	0

Auto cleaning

Activate

Cycle [min] 120

**Ignition** - through this menu we set the number of ignition attempts (**Number of attempts**), working time of the feeder to load the first dose of pellets (**Feeding**), the speed of the additional fan throughout the ignition period (**Second fan**) and the maximum duration of each of the three ignition stages as well as the fan speed in each stage.

	Sec	Fan
Stage 1	30	--
Stage 2	120	10
Stage 3	180	20

*If the photosensor detects fire, the ignition procedure stops immediately and goes to burning!*

**Burning** - Adjust the smooth burning process to stabilize the fire after ignition. The upper field adjusts the fan speed, basic and chimney as well as the duration (**Duration [sec]**) of the first dose burning period. During the burning of the first dose no new pellets are loaded. The lower field sets the retention time of each power in the process of smoothly increasing the power from the smallest P1 to reaching the nominal, according to the temperature of the water in the fireplace.

**Power P1, Power P2, Power P3, Suspend** - Simultaneous menus for adjusting the operating parameters for each power from the smallest **P1** to the one for fire maintenance. In order to accurately measure the amount of pellets, the **portion** line is set, which is the run time of the screw and the **Cycle** row, which is the time between two fuel delivery periods. In order to properly burn the fire, it must be given adequate air. Therefore, fan speeds (**row Fan**) and auxiliary fan (**row Add. fan**), if any, must also be set.

We recommend that you adjust the power P3 to the maximum power you will want to get from the fireplace. P2 power is better to be 50% of P3 and P1 to be 20% of P3. With such a setting, the controller will be able to modulate the power of the fireplace in a range of 20 to 100% by varying the power if required for each new cycle. For example, if you need 75% power, the controller will go from power P3 to P2 and then back to P3 at equal intervals. Thus the average power can be reduced to the following  $(100 + 50) / 2 = 75$ . The switching time will depend on the systems inertia and the set temperature differences in the menu „**Service settings**“ -> „**Power modulation**”

The smallest interval for switching between two capacities may be one cycle. For such a small switching period, the temperature of the heating system will not change appreciably to feel the pulsation of the power. By adding “Suspend” power that will be less than P1, the fireplace receives an even wider modulation range.

**Interm cleaning** - From this menu, an additional feature is set which the NPBC-V3C-G2 controller allows, called „**Interm cleaning**”. The idea is that while the burner is operating normally, it only increases fan speed, which will temporarily raise the temperature of the fire and this will result in more burning of slag and ash. A mechanical cleaning mechanism connected to a FC outlet can also be used to activate periodically until the fire is burning to scrape the slag or ash. To do so, you should mark the row "**FC Output**" and perhaps remove the mark for row "**Change fans**".

F1> Interm cleaning	
Activate	<input type="checkbox"/>
Cycle [min]	10
Duration [Sec]	30
Change fans	<input checked="" type="checkbox"/>
Main fan	75
Exhaust fan	0
FC Output	<input type="checkbox"/>

If is marked the interm cleaning will on.

On every 10 min. work, will be cleaned for 30 sec.

At interm cleaning the turnovers of the fans will changed to 75% main and 0% chimney.

At interm cleaning the FC output will be activated.

**Additional information about the controller operation**

After the power is turned on for 2 seconds, a yellow inscription will appear with the control module.

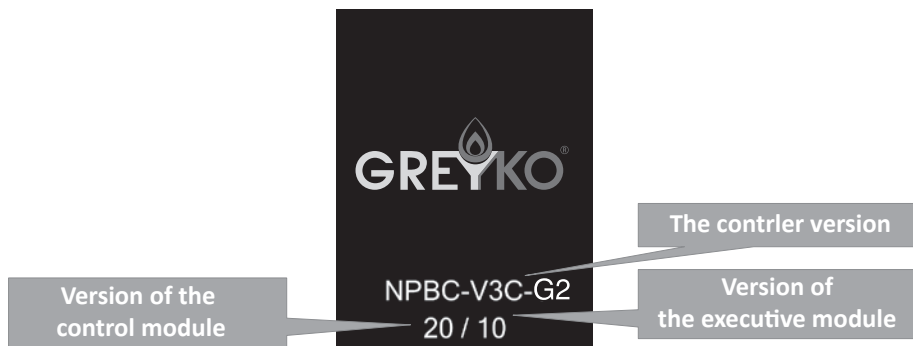

If there is no upgrade to the main screen within 3 seconds, and the version of the executive module is missing (there will be only -), there is a problem with the communication between the controller and the executive module or the executive module does not work. To localize the problem, you have to look at how the green LED on the board is blinking. In normal operation, it will light up and go out for 0.5 seconds, and if it blinks, the problem may be in the connection between the two modules. If, after the power is turned on, the LED turns on and goes out for 2.4 seconds, it indicates that there is no loaded software in the executive module. To solve the problem, you will need to load the software with the remote monitoring program. If after the power is turned on, the LED flashes and goes out for 1 second means that there is no communication between the two modules and you need to check the connection between them.

If there is no change to the main screen within 3 seconds, and the controller version becomes red, there will be a hardware incompatibility between the control and execution module.

If the main screen does not switch to the main screen within 3 seconds, and the version of the software in the executive module becomes red, there will be software incompatibility between the control and execution module.

## 7. Cleaning and maintenance of the Bijou pellet fireplace.

**IMPORTANT!** Cleaning of the facility should be done periodically and in accordance with the manufacturer's recommendations.

Clean the fireplace burner daily!

Clean the glass from smudges, and also clean the smoke pipes with fig. 1

Clean the smooth surfaces of the combustion chamber.  
When cleaning, use a suitable vacuum cleaner.

Clean the equipment mainly after burning 1000 kg of pellets.  
Clean the gear mainly at the end of the season.

**ATTENTION!** Cleaning is done when the appliance is switched off and has cooled down and power is off! Do not use flammable cleaners!

At the end of the heating season it is mandatory to perform prophylaxis from an authorized service center that includes:

- Cleaning the fan;
- Checking the data and the performance of the electronic controller;
- Cleaning the outlet chamber through two inspection holes;
- Clean the top chamber through the top inspection cover;
- Check the state of the sealing rope of the door;
- Checking the silicone pressure hose;
- Inspection of the smoke extraction system;
- Check the fresh air inlet pipe;
- Checking the ignition system.

**After performing the actions above, the authorized service facility issues a prophylactic protocol.**

Cleaning the glass.

The glass has a self-cleaning system through the air holes in the front of the combustion chamber, but it can cause the glass to become dirty on the inside with the time.

**Manual glass cleaning is performed with the extinguished and cooled fireplace.** It is advisable to use a dry cotton cloth, but if the effect is not full, put a small amount of detergent on the cloth.

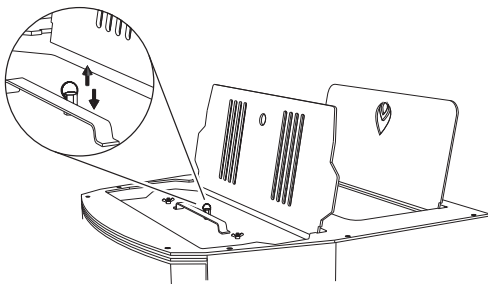

1 For cleaning of the chimney pipes, you need to pull up and release down multiple times the ring from the cover. Thus the soot deposits on the pipes will fall into the exhaust gas chamber.

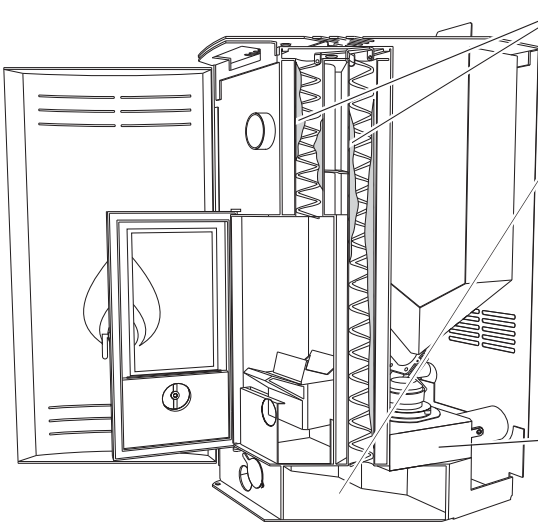

**Soot deposits**

**Chamber of exhaust gases**

In the beginning or ending of the every season the impeller needs to be cleaned. **Contact a service technician for this!**

**Cover for access to the flue gas fan impeller.**

2 Clearing the output chamber of the flue gases can be done from the revision covers located of the bottom side on the fireplace. Clean the ash with a suitable vacuum cleaner.

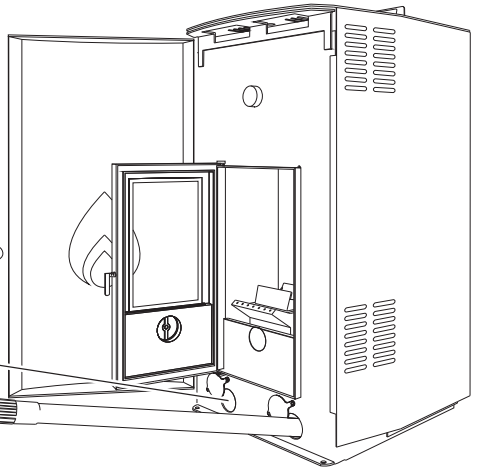

**Revision openings**

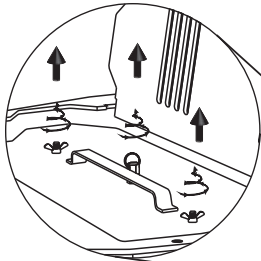

4 To access the turbulator springs and chimneys, unscrew the wing nuts located on both sides of the lid handle and the nut with the ring.

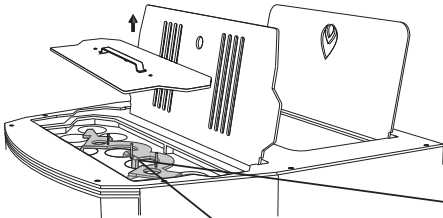
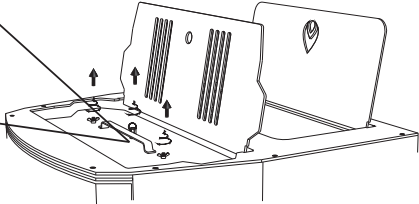

5 Pull the cover off the studs

Chimneys

Studs

Holder of turbulators

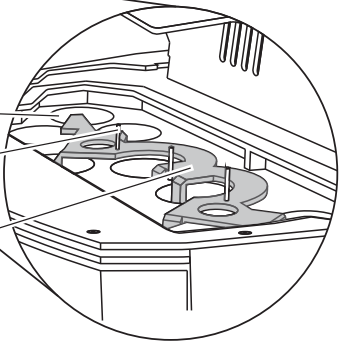

6 The ashtray is located under the combustion chamber. To clean it, simply pull it out and pour its contents into a metal waste container.

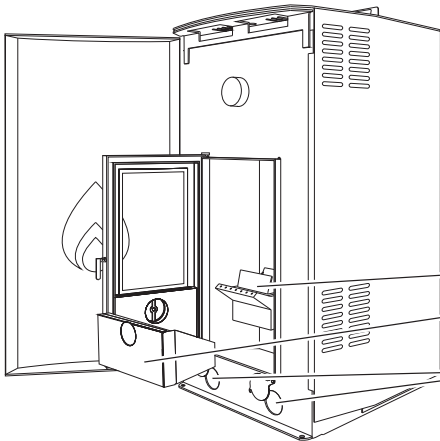

Combustion chamber

Ashtray

Revision openings

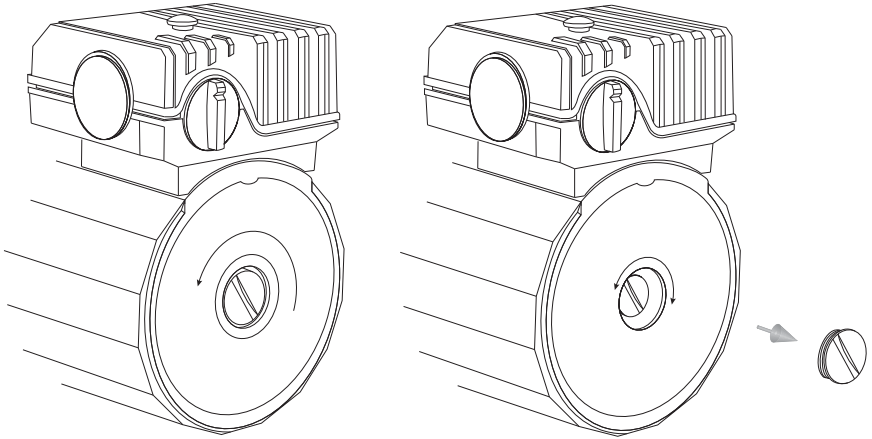

Manual movement of the water pump rotor is required at the beginning of each season. To do this contact an authorized distributor!

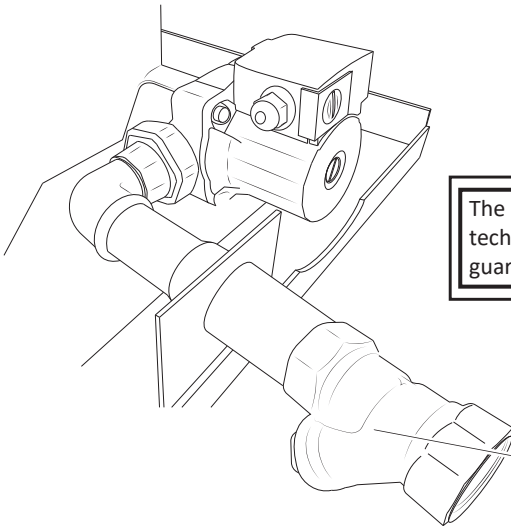

The Y-filter is fitted by an authorized service technician. Failure to do so will void the guarantee of the water pump!

**Y - filter**

### **Cleaning the outer surface.**

To clean the outer surface, use a dry cotton cloth.

### **Clean the ash residue from the fireplace.**

Clean the ash tray at the bottom of the combustion chamber daily. Raise the burner and clean the air cavity below it. When cleaning, use a suitable vacuum cleaner.

**Cleaning is done when the fire extinguished and cooled.**

### **Cleaning the pellet hopper.**

Cleaning of the pellet hopper is required if there is a large amount of dust and sawdust in the hopper. Perform as follows - empty the hopper from available pellets. Clean it with a vacuum cleaner. Load the hopper again with pellets.

### **Cleaning of the pipe system.**

The pipe system is cleaned by means of the ring above the inspection chamber of the top chamber by pulling upwards and releasing down several times (reciprocating movement).

**ATTENTION! IF THE FIREPLACE WORKS, THE HOOP IS HOT! USE GLOVES!**

## **8.Service.**

The equipment is purchased from an authorized distributor who completes the warranty card. For any problems encountered during the warranty period, please contact your authorized distributor. It can also take over after-warranty service.

## **9.Warranty conditions.**

**IMPORTANT!** The manufacturer guarantees for the correct and reliable operation of the Bijou pellet fireplace only when complying with the requirements for installation and operation during commissioning and service.

**IMPORTANT!** The circulator pump warranty only applies to a type "Y" water filter just before it!

The warranty of the Bijou pellet fireplace starts from the date of filling and stamping the warranty card. The guarantee of the Bijou pellet fireplace begins from the day of commissioning but not more than 6 months from the date of sale. The warranty period of the Bijou pellet fireplace is 24 (twenty-four) months.

The warranty is valid only on invoice and original warranty card.

## THE PELLET FIREPLACE WARRANTY DOES NOT APPLY IN THE FOLLOWING CASES:

- \* Damage to the pellet fireplace caused by improper storage, transport and / or unloading, which are not organized by the manufacturer;
- \* If the installation, operation and periodic maintenance conditions specified in this manual are not met;
- \* Attempt to remove the defect from the buyer or other unauthorized persons;
- \* Changes in the structure of the pellet fire module;
- \* Incorrect design for installation and operation of the pellet fireplace;
- \* Accidents caused by natural disasters (earthquakes, fires, storms, floods, etc.)
- \* Damage due to factors for which the manufacturer has no fault (where there is no control);
- \* Interference and damage not caused by the fireplace itself but resulting in damage to its structure;

### 10. Actions after stopping the use of the Bijou pellet fireplace.



Tips for protecting the environment.

#### Disposal of packaging materials

Different packaging materials should not be disposed in the environment but must be handled in accordance with all local authority regulations.

#### Discard the pellet fireplace

The pellet fireplace is marked in accordance with European Directive 2002/96 / EC "Waste electrical and electronic equipment" (WEEE). By ensuring that the facility is properly disposed, the user contributes to preventing potential hazardous consequences for the environment and human health.

The symbol on the facility or the accompanying documentation indicates that it must not be treated as household waste but must be handed over to the relevant collection and recycling point of the electrical and electronic equipment.



**IMPORTANT!** After stopping to use the pellet fireplace Bijou, it is required to not cause environmental pollution while destroying it! After dismantling and separate collection of the parts, it must be submitted to licensed collection points!

# 11. Electric circuit diagram

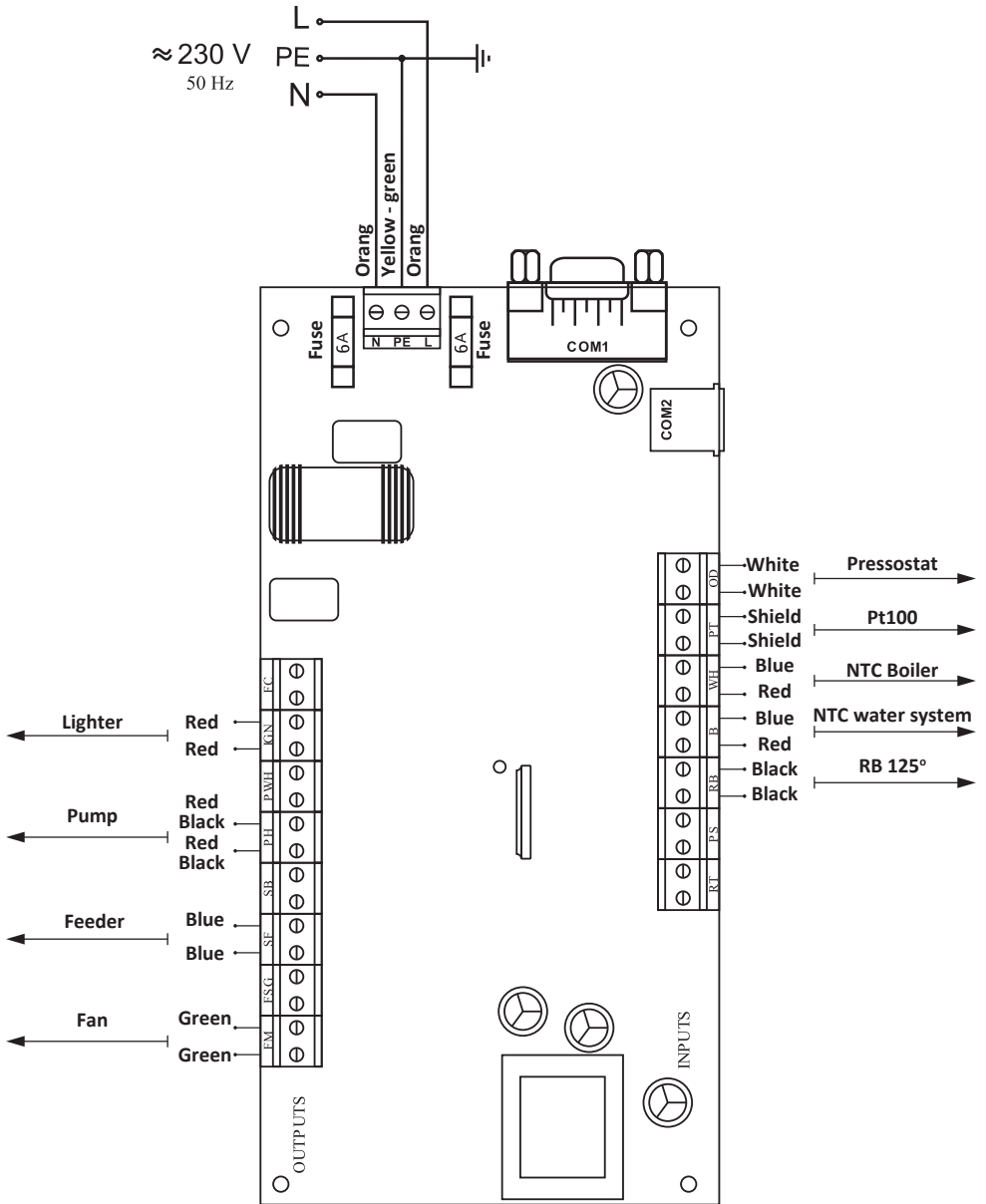

## **A Guide to Working with a Web Based Remote Monitoring and Control System**

The Naturela Smart Home system is designed to remotely monitoring and managing the latest generation of intelligent electronic controls produced by Nature. The system works with data transfer over the Internet, thanks to which it does not matter where you are and where your facility is located. It only needs Internet access in both places. To connect to the system, controller must be able to work with the NRM-W3 WiFi module. Key benefits of the Naturela Smart Home system:

- Provides you with constant and up-to-date status information for your facility that has built-in control over the Web site. The system monitors and displays all important parameters measured by the controller.
- Allows remote adjustment of all operating variables relevant for proper operation of the unit.
- Allows you to remember the settings in a file so you can easily restore the facility's performance if you mistakenly confuse a setting or change the controller.
- Allows creation of service centers for all facilities connected to the system. To do this, you can authorize another user or users to monitor and manage the facility for you. So you can trust a more qualified team to adjust the operating parameters in such a way that you can save more or better the equipment.
- Visualizes and remembers the statistics of your facility's operation.
- Displays and remembers information with registered events from the self-diagnosis system.
- Allows Remote Software Upgrade in the controller. This option does not work automatically and is only done by the Naturlex specialists in consultation with you!

To turn on your new device with the necessary controller and modem to the system, you must first turn on the power supply. Then you need to connect it to your home WiFi network by following the procedures below.

### **Connect the WiFi module NRM-W3 to the home Internet network**

To connect your controller with the remote monitoring and control system over the Internet, you must first connect the WiFi module to your home network.

*To connect the WiFi module to the system server, the Internet network must have an authorized 32006 outbound port for TCP packages.*

To do this, you need to know the network name, password, and encryption. As an aid you will need to use any smartphone, tablet or laptop with WiFi modem. Before proceeding to connect the controller to your home network, you must run the "New WiFi Network" menu for pellet burner and boiler controllers, "Preinstallation WiFi network" in the controllers for electric and combined boilers, or use the Access Point of the WiFi modem.

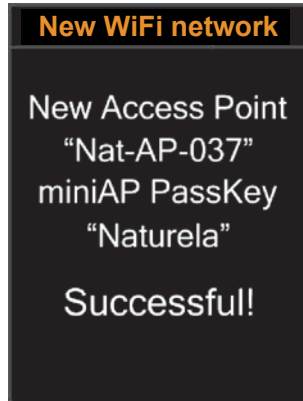
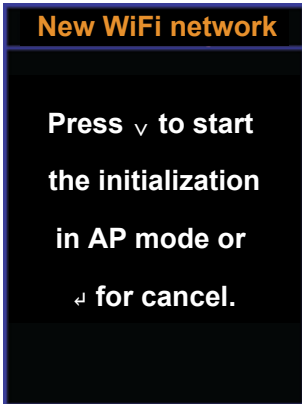

After pressing the down arrow, a screen similar to the one below will appear, from where you can see the name of the new WiFi network that will appear from the WiFi module. In this case, the name of the new network is: **Nat-AP-037**.

You must then enable the smartphone WiFi network to set up. To ensure that the browser will only work with the WiFi module, stop the Internet from GPRS on the phone. You need to select the new network created by the modem called **Nat-AP-xxx**. Selecting a new network is from a menu similar to "**Settings**" and submenu "**WiFi**" or similar. From the screen below, you can see how this menu should appear in an **Android** phone. The **Nat-AP-xxx** network is unencrypted and after you select it you will be contacted immediately. Wait a minute in this phone menu to make sure it is connected to the WiFi network.

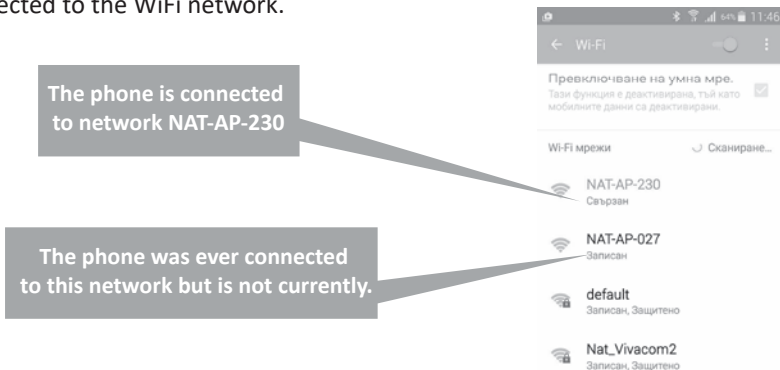

Once the phone is connected to the Access Point of the NRM-W3 WiFi Module, you can continue connecting the modem to your home WiFi network or using one of the browsers on your Android or Windows phones or the Smartphone Mobile app on the iPhone.

If you are using a browser to initialize the modem, enter the address: `iconnect.net` in the Address bar. After that, a page that looks like the one below should appear:

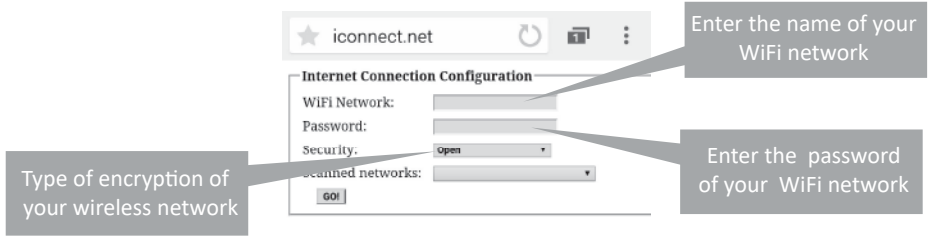

After you turn on the power or log in to the New WiFi Network, the modem scans nearby WiFi networks and you can select your network from the list of scanned networks by pressing the selection arrow in the list of networks.

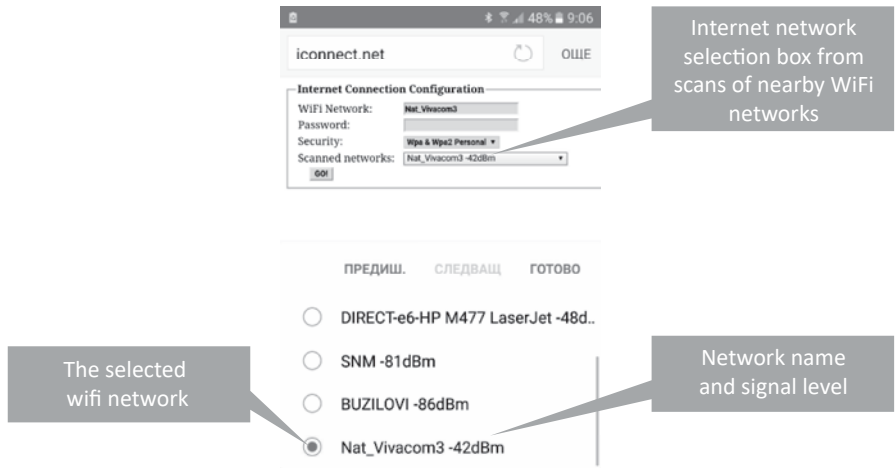

If you find your network in the list of networks, you will only need to enter your password in the Password field. If the modem does not detect your network or it is hidden for it, you will need to enter all the fields: network name, password, and encoding method.

For each of the Internet networks found, the signal level received by the WiFi module is also displayed. Because the levels are negative, the smaller number means that the signal is better. The modem can work well for a signal with a number below 70. Signal levels above -80dBm are not recommended for use. In this case, move your router antenna closer or plug in an additional router or amplifie.

After entering all these parameters, you must go ahead by pressing the GO button. Then a new confirmation screen like this one will appear:

To confirm the connection operation is Internet, press OK. Within a few seconds the network that was on the WiFi modem will turn off and the phone can now connect to any other network by default or stay out of the network.

You can also use the Smart Home Mobile app, which you can download from Google Play or the Apple Store, by using the QR codes below or by linking the Google Play or App Store logos:

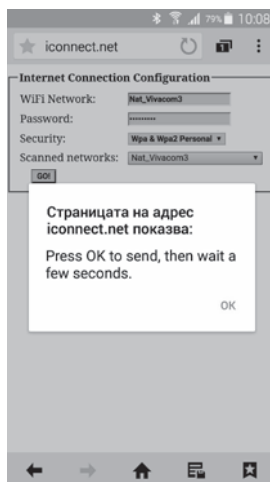

After downloading and installing the application, you must turn on the WiFi module you want to initialize in the Access Point mode as described on page 2. Next, you need to connect your phone to the network of the module described on page 3. Then you can launch the application through its icon:



After launch, the application screen that consists of two pages Client and Settings will appear. The Client page can be used to access the monitoring and management system: Naturela Smart Home. For this page to work normally, your phone needs to be connected to the Internet. If you want to initialize the WiFi module NRM-W3 and connect your phone to the WiFi network, then you need to use the Settings.

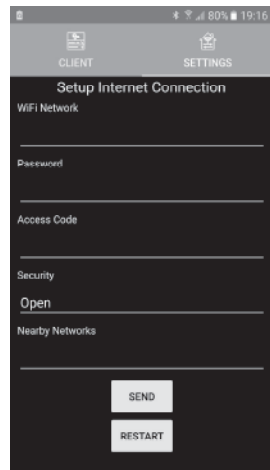
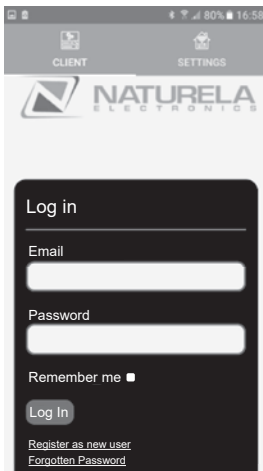

The parameters that need to be entered are the WiFi Network, the Password, the Access Code, which is the last 4 letters of the Modem ID and the Network Encryption Method (Security). **Fig. 1**



If the WiFi module is connected with the application, here will be showed the version of the him software.

Click here to see the scanned networks by the WiFi module.

**Fig. 1**



**Fig. 2**

Keep in mind that only NRM-W3 modules with a software version of 37 upstream provide information about nearby networks.

You can use the Nearby Networks box to enter the network name and encoding method. Then scanned nearby networks will be displayed, and you can choose which network to connect to the WiFi module. **Fig. 2**

By entering the information required for the connection, you must send it to the WiFi module using the SEND button. Upon successful completion of the initialization, the full ID of the WiFi module will appear in the Device ID field. This number can be copied and used when adding a new device through the information system.

The full ID of the WiFi module can be copied

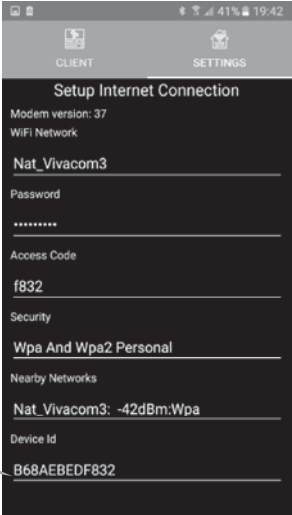

Once you connect the modem to the Internet, the phone will be unlinked and, depending on the settings, it will connect to one of the other networks running the Internet. You can then switch to the Client page to connect to the Naturela Smart Home information system. When you first connect to this system, you will need to enter your username and password, but if you tick the "Remember me" checkbox, all subsequent entries in this application will immediately link you to the internal pages of the monitoring and management system.

Although the modem does not need uninterrupted connections through this app because it will remember all settings, you can use the Naturela Smart Home application through its Client page.

When you finish the procedures for connecting the WiFi modem to the home network, it will try to connect to it and then start sending and receiving packages from the server on the Internet. To make sure this has happened, you can look at the screen information „WiFi свързаност“. Look at whether the IP address is from your network (if you know it), whether the WiFi mode is in the "Connected" state, and whether both counters under Snd / Rcv are increasing. The rate of increase of the counters may be relatively small, by one minute per minute.

If there is any connection problem, you can try again through all the steps for a new installation, starting from the Access Point mode of the WiFi modem.

The modem remembers all the settings made and even when the power goes out, it will not need a new initialization and data entry on the home network. The procedure here will only need to be done if you change the location of the WiFi module or router on your home network.

## **ATTENTION!**

*WiFi modules can only connect to networks that have letters, numbers, or underscores in their name and password. No other characters, such as spaces, are allowed!*

*If your network encoding is WEP, the password will be entered using the appropriate hexadecimal number representing each letter.*

*If you enter a wrong password for a network name, you may need to enter it twice in a row correctly to connect the modem to the router. Before each entry, you must go through the "New WiFi Network" feature ("Wi-Fi network upgrade").*

## User Interface of the Remote Monitoring and Control System.

For convenience, the user interface of the system is web-based. Thanks to this, you will have a secure method of accessing your devices through your phone, tablet, or computer browser. For more complete user interface functionality, we recommend using **Google Chrome** or **Mozilla** browsers. The address for remote monitoring and control system access is:

**iot.naturela-bg.com**

To login to the user interface, you need to start your browser and type in its address bar: **iot.naturela-bg.com**.



Each user must create their own profile in the system in which they must enter their real email, which is also a login for the system, password, and their names. When you log in, you will need to be authorized by entering your login and password and clicking the **"Login"**.

If you do not have a registered account in the system, you should use the "Register new user" line. The screen for entering your personal information is as follows:

It is important to use a real "E-mail", because through it we will reset your password if you forget it. Finally, you'll also need to highlight the 'I'm not a robot' checkbox to allow your account to be registered. This is to avoid malicious programs that can detect invalid accounts. The form is Google, and if there is any doubt about whether a robot program is entering an account, it may ask you additional questions.

*If you get or relinquish the right to manage your devices to another, it will see your name as the owner of the recipient device.*

*Obtaining rights happens as you provide your e-mail address to the owner of the device.*

## Restore a forgotten password

If you have forgotten your password, you can use the "Forgot password" line on the Sign In screen, then a new screen will appear to enter the email with which you first registered.

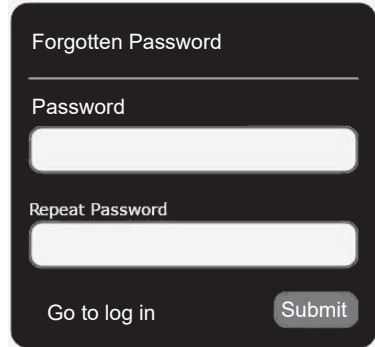
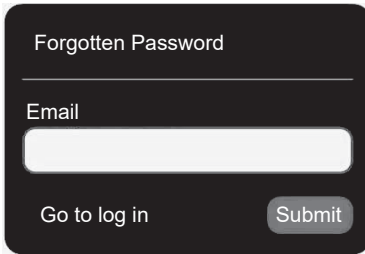

Once you click on the "Send" button, you will receive an e-mail with a link at the start of which you can change your password. Then a screen like the one below will appear:

Keep in mind that this link will only work for 24 hours!

After successfully entering your email and password, a new screen will open with all your registered devices or with those devices for which you have received management rights. At the top of the left field, you see your email address and the name you signed up for. Here are the "My Devices" buttons by pressing all of the devices and devices that you can access and "Account Setup".



Device ID	Last Active	Time Zone	Grant Access	Owner
F3B3EC585A32	04/04/2017 14:40	UTC+02:00	+	
F5EC5A383432	04/04/2017 14:40	UTC+02:00	+	
cd6d41332132	04/04/2017 14:40	UTC+02:00	+	ar Galodov

## Change user name.

When you click on "Account Settings," you'll see two new buttons: "Change Name" and "Change Password". By clicking "Change name" you will get to the following screen:

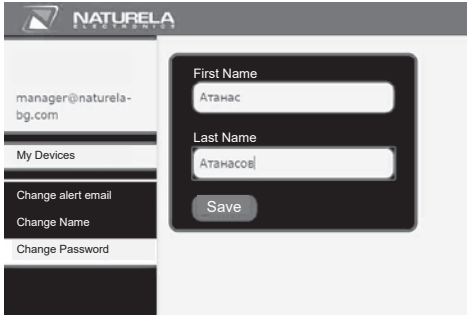

The screenshot shows the 'Change Name' form. On the left is a sidebar with the user's email 'manager@naturela-bg.com' and menu items: 'My Devices', 'Change alert email', 'Change Name', and 'Change Password'. The main form area has two input fields: 'First Name' with the value 'Атанас' and 'Last Name' with the value 'Атанасов'. A 'Save' button is located at the bottom of the form.

Here you can change the name with which you are registered in your account. After entering a new name, click on the "Save" button. If you've decided to opt out of a name change, just press the buttons on some of the other features like My Devices, for example.

## Password change

When you click on "Change Password" you will be able to change the password. To do this, however, first enter the old password and then the new password and then repeat it. When you click on "Save", your password will be changed to the new password. If you want to cancel, press the buttons on some of the other features, such as My Devices, for example.



The screenshot shows the 'Change Password' form. The sidebar is identical to the previous screenshot. The main form area has three input fields: 'Old Password', 'New Password', and 'Confirm new password'. A 'Save' button is located at the bottom of the form.

## General information about the devices you are entitled to manage.

When you click on "My Devices" for a separate device, there will be a field that contains: the name you entered for your device, indicating the device type, the device modem identifier, the last time automatic data is sent from your device, the time zone in which your device is located, the "Give access" and "Remove".

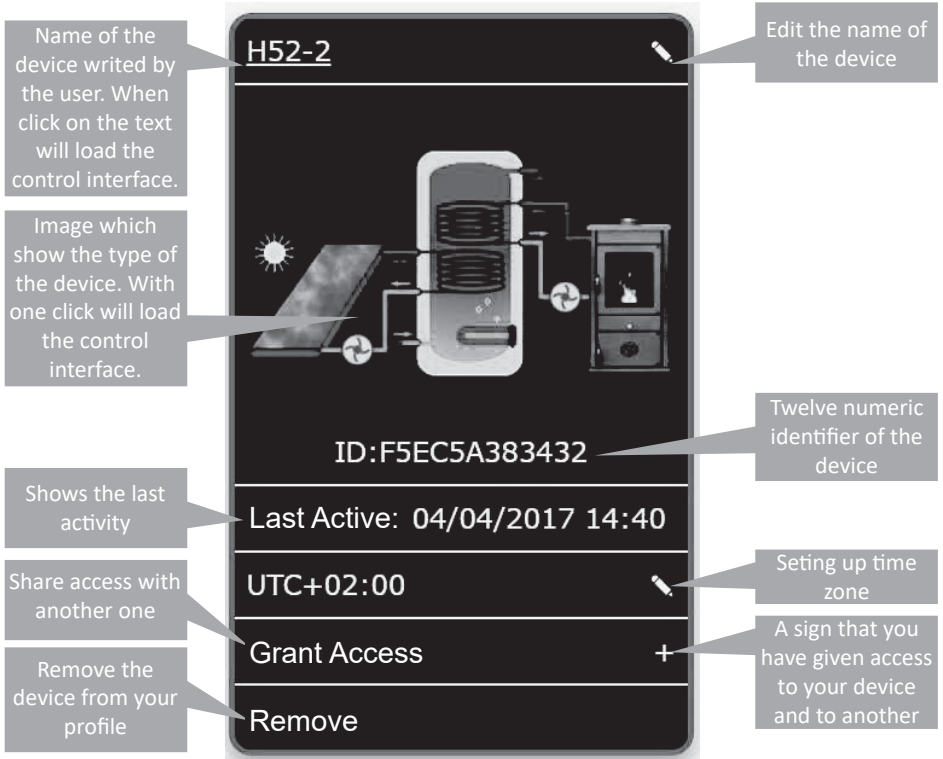

## Add a new device to your personal account

If you have not yet added your device to your account, you can do so by pressing the "+" sign on the screen. The screen for entering your new device ID will then appear. The way you can find your device ID is described in the operating instructions for the particular appliance type.

*Keep in mind that the ID number should not have spaces!*

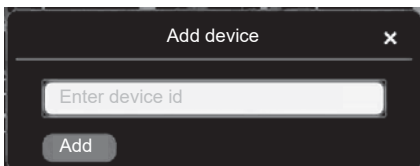

By clicking Add, your new device will be added to the system. It may take up to a few minutes to build a connection channel for your device. Once the system connects to your device's controller, it will automatically get information about what type of controller it is and will output a picture appropriate to its version. When a new device is turned on, you must enter its name. This is only for your convenience if you have many devices connected to this system. You should also enter the time zone where your appliance will operate. The time zone is important to automatically adjust the clocks of each device.

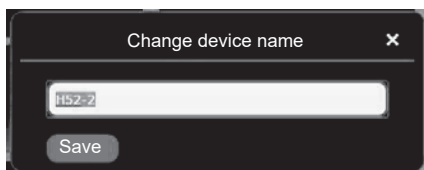

*After changing the time zone, the clock on your device will be updated within a few minutes, but only if an automatic scan from the Time and Date menu.*

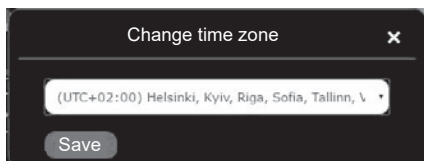

*Keep in mind that the device you entered first becomes your property, and only you can assign rights to its management and only you can release it from the system. While a device is your property, no one else will be able to add it to its own account.*

*We recommend that you do not delay the addition of your new device to your account. There is a small chance that someone else by mistake will hit the ID of your device, but it is not excluded.*

*Adding a device to the account should be done after connecting it to the Internet.*

### **Giving access to your devices to other system users**

If you do not think you are qualified enough to monitor and set up your appliances that are included in the remote monitoring and control system, you can look for another more competent user of the system who wants to monitor and manage your devices. This could be a service base or a service company for appliances like yours. To grant access to this organization, you must click on the "grant access" line. Then a screen like the one below will appear, where you will need to enter an e-mail to the one who will get your management rights.

A list of those you have authorized to manage your appliances.

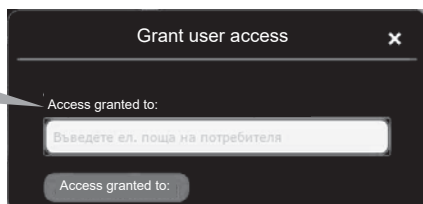

*Those who get management rights do not have all of your rights. They will not be able to pass on the management rights and will not delete the device from the system. However, they will be able to delete your device from your list of devices.*

## Input to the interface for monitoring and controlling your appliances.

To login to the management interface of each of your devices, you need to click on the device name or the targeting picture. You will then enter the page for displaying information or making settings for the particular device. Pages differ depending on the type of device, as well as the hardware and software versions.

## Releasing a device connected to the system.

If you sell your appliance, the new owner will probably want to control it himself online. Therefore, you must release your former appliance from the list of your appliances. This is done by clicking on the "Remove" row".

## FACTORY SETTINGS OF THE BIJOU PELLET FIREPLACE

MENU	SETTING	VALUE			
Select fuel	Fuel number	1			
Info Field	Info fields	1	Exhaust Temp		
		2	Timers		
		3	Power		
		4	Remaining time		
Display	Brightness	7			
	Display date	<input type="checkbox"/>			
Pump Settings	Pump operation	CH priority			
	CH pump	Pump on	60°		
		Hysteresis	5°		
	DHW	WH set temp	40°		
		Hysteresis	5°		
Manual Feeding	Feeder	<input type="checkbox"/>			
	Pumps	Heating	<input type="checkbox"/>		
		DHW	<input type="checkbox"/>		
New WiFi network	Press to start	↓			
<b>Factory settings</b>					
Equipment	Vacuum sensor	<input checked="" type="checkbox"/>			
	Thermostat	<input type="checkbox"/>			
	Contact NO	<input checked="" type="checkbox"/>			
	CH Pump	<input checked="" type="checkbox"/>			
	DHW Pump	<input type="checkbox"/>			
			<b>FEEDER VALUE</b> 5.3 rpm, 8 rpm		
			<b>5.3rpm / 10kW</b>	<b>5.3rpm / 16kW</b>	<b>8rpm / 25kW</b>
General Settings	Max Temp		80°		
	Feeder capacity	Fuel [kg/h]	8,2	8,2	12,4
Flame detection	Exhaust gases temperature	higher	5°	5°	5°
		lower	0°	0°	0°
	Extinguishing time max [min]		10		
Power Modulation	Power Level	P3 ΔT>	6°	6°	6°
		P2 ΔT>	3°	3°	3°
		P1 ΔT>	0°	0°	0°
	Suspend mode	Duration [min]	20	20	20
		Overheating	5°	5°	5°

Burning setup	Fuel 1	Cleaning	Fan [sec]	Start	20	20	20
				Stop	20	20	20
				Alarm	0	0	0
		Auto cleaning	Activate	<input type="checkbox"/>	<input type="checkbox"/>	<input type="checkbox"/>	
			Cycle [min]	120	120	120	
			Ignition retries	1	1	1	
		Ignition	-	Loading [sec]	50	80	46
				Second fan	0	0	0
				Sec	Fan	Fan	Fan
			Stage 1	20	-	-	
			Stage 2	300	34	36	36
			Stage 3	180	38	40	40
		Unfolding fire	Burning first dose	Duration [sec]	100	100	100
				Fan	34	36	36
				Second fan	0	0	0
			Smooth unfolding	P1 [sec]	10	10	10
				P2 [sec]	180	180	180
		Setup P1	Loading fuel	Feed [sec]	4,0	6,0	4
				Cycle [sec]	50	50	50
				Fan	28	30	30
				Second fan	0	0	0
		Setup P2	Loading fuel	Feed [sec]	6,0	10,0	6,6
				Cycle [sec]	50	50	50
				Fan	32	34	34
				Second fan	0	0	0
		Setup P3	Loading fuel	Feed [sec]	12,0	19,6	12,9
				Cycle [sec]	50	50	50
				Fan	36	38	38
				Second fan	0	0	0
		Suspend	Loading fuel	Feed [sec]	3,1	5,0	3
				Cycle [sec]	50	50	50
				Fan	28	30	30
				Second fan	0	0	0
		Interm Clean	Activate	<input checked="" type="checkbox"/>	<input checked="" type="checkbox"/>	<input checked="" type="checkbox"/>	
			Cycle [min]	90	90	90	
			Duration [Sec]	10	10	10	
Change fan	<input checked="" type="checkbox"/>		<input checked="" type="checkbox"/>	<input checked="" type="checkbox"/>			
Main fan	100		100	100			
Second fan	0		0	0			
RT Control	Power decrease	P3 [sec]	60	60	60		
		P2 [sec]	60	60	60		
		P1 [sec]	60	60	60		
Output test	-	FM	0	0	0		
		FSG	0	0	0		
		SF	<input type="checkbox"/>	<input type="checkbox"/>	<input type="checkbox"/>		
		SB	<input type="checkbox"/>	<input type="checkbox"/>	<input type="checkbox"/>		
		PH	<input type="checkbox"/>	<input type="checkbox"/>	<input type="checkbox"/>		
		PWH	<input type="checkbox"/>	<input type="checkbox"/>	<input type="checkbox"/>		
		IGN	<input type="checkbox"/>	<input type="checkbox"/>	<input type="checkbox"/>		
		FC	<input type="checkbox"/>	<input type="checkbox"/>	<input type="checkbox"/>		
Safety Setup	Exhaust Temp	Warning >	200°	200°	200°		
		Extinguish >	220°	220°	220°		
Quick stop	Press ▼ to stop the burner or ↵ for cancel			↓			



**GREYKO<sup>®</sup>**

[www.greyko.com](http://www.greyko.com)